

# VENEZIA BY VENINI

MANUALE TECNICO

# VENEZIA by VENINI

design Matteo Thun & Antonio Rodriguez



95 S704S + 95 V748CN (2 PCS)

Maniglie	pag. 399
LAVABO	pag. 401
BIDET	pag. 403
DOCCIA	pag. 406
VASCA	pag. 424
ARTICOLI VARI	pag. 429

## Informazioni tecniche

**VENEZIA by VENINI è fornita di serie SENZA MANIGLIA, da ordinare separatamente.**

I miscelatori lavabo e bidet sono dotati di **aeratori limitati** a 5 l/min.

- VERSIONE CARTUCCIA PROGRESSIVA

Ruotando la maniglia di 180° in senso antiorario si passa da **acqua fredda > acqua miscelata > acqua calda.**

### FORATURA DEI PIANI SANITARI:

- Gruppo lavabo e bidet monoforo.



- Gruppo lavabo 3 fori.

art. S704S

art. S705S

art. S804S

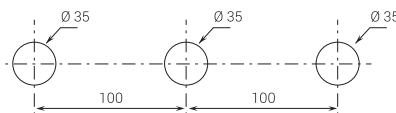

## Miscelatori - pulsanti ON/OFF

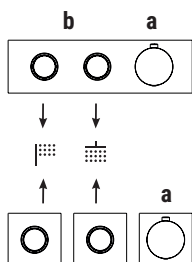

I miscelatori termostatici doccia 3/4" con pulsanti ON/OFF e regolazione della portata sono disponibili con piastra "unica", dove termostatico e pulsanti sono integrati (art. H572B+H572A), oppure con miscelatore termostatico e rubinetti d'arresto (con rosoni) ordinabili separatamente (art. H500B+H500A o art. H590B/H591B/H592B+H590A).

ESEMPIO:

**art. H572B+H572A o art. H500B+H500A / H590B+H590A / H591B+H590A**

**a)** comando per la regolazione della temperatura.

**b)** comando per: - funzione ON/OFF mediante pressione del pulsante  
- funzione di regolazione flusso mediante rotazione della ghiera

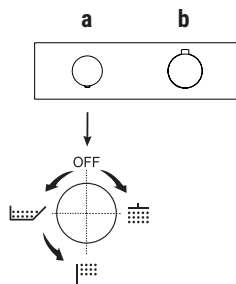

**Il miscelatore termostatico doccia incasso 3/4" è disponibile:**

- art. **G572B+D372A** - 2 uscite

- art. **G573B+D373A** - 3 uscite

ESEMPIO:

**art. G573B+D373A**

**a)** deviatore a rotazione con chiusura - Partendo dalla posizione centrale ruotando verso DX si attiva la 1° uscita, al centro la chiusura, ruotando verso SX si attivano consecutivamente la 2° e la 3° uscita.

**b)** comando per la regolazione della temperatura.

**Materiale di base:** OTTONE

**Finiture:**

02 Cromo

95 Polished Nickel PVD

P5 Matt Gun Metal PVD





P6 Matt British Gold PVD

P9 Matt Copper PVD

S9 Golden Look PVD

\* Per eventuali ricambi, accessori, articoli vari e prolunghe consultare le relative sezioni del listino

## Tipologie e colori delle maniglie

	V748  CN	V748  CM	V748  CO	F948  CP	F948  CQ
02 Cromo	•	•	•	•	•
95 Polished Nickel PVD	•	•	•	•	•
P5 Matt Gun Metal PVD	•	•	•	•	•
P6 Matt British Gold PVD	•	•	•	•	•
P9 Matt Copper PVD	•	•	•	•	•
S9 Golden Look PVD	•	•	•	•	•

### Maniglie Venezia by Venini in vetro di Murano bicolore e filigrana

Queste maniglie hanno una base in metallo disponibile in diverse finiture.

Magistralmente modellate dalla storica vetreria Venini di Murano, le maniglie Venezia bicolore e filigrana rappresentano un prodotto nato dall'incontro tra design e artigianato artistico italiano. La magia della trasparenza, la fluidità del colore e la nobile arte del vetro di Murano si fondono e danno vita a piccoli capolavori di bellezza ed eleganza.

Eventuali sfumature o bollicine che si possono presentare nel vetro sono tipiche imperfezioni presenti nella lavorazione artigianale del vetro. **Questi segni** fanno parte della bellezza e dell'autenticità di un prodotto di alta qualità fatto a mano in Italia e contribuiscono a rendere ogni pezzo unico ed irripetibile.

Le maniglie **VENEZIA by VENINI** possono essere installate solo sui corpi / codici articolo Venezia by Venini contenuti in questa sezione del listino. Qualora si volesse installare le maniglie **Venezia** su corpi Venezia by Venini, acquistare kit di fissaggio specifici (art. Z332 e art. Z333).

VITONI CERAMICI DA 1/4 DI GIRO

**Gruppo lavabo 3 fori**  
\_interasse bocca 17,5 cm



**S704SW**  
SENZA SCARICO  
**S704S**  
CON SCARICO

**Gruppo lavabo alto 3 fori**  
\_interasse bocca 17,5 cm



**S705SW**  
SENZA SCARICO

**Gruppo lavabo da parete**  
\_interasse bocca 20 cm



**S713SB+R010A**  
SENZA SCARICO

**Gruppo bidet 3 fori**  
\_interasse bocca 12 cm



**S709SW**  
SENZA SCARICO  
**S709S**  
CON SCARICO

**Gruppo bidet**  
\_interasse bocca 12 cm



**S711SB+R011A**  
comandi remoti a parete  
CON SCARICO

IDROSPRAY / IDROSCOPINO

**Idrospray**



**E857B+M111A**

**Idroscopino**



**W291**

**V748CN**

**Maniglia VENEZIA by Venini in vetro di Murano - BICOLORE ACQUAMARE VERDE**

- supporto maniglia in ottone
- per articoli: S704SW - S704S - S705SW - S713SB - S709SW - S709S - S711SB - S765S - S767S - S991SB - S719SB - S717SB



Cromo	29 02 V748CN
Polished Nickel PVD	29 95 V748CN
Matt Gun Metal PVD	29 P5 V748CN
Matt British Gold PVD	29 P6 V748CN
Matt Copper PVD	29 P9 V748CN
Golden Look PVD	29 S9 V748CN

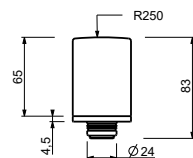

**V748CM**

**Maniglia VENEZIA by Venini in vetro di Murano - BICOLORE AMETISTA AMBRA**

- supporto maniglia in ottone
- per articoli: S704SW - S704S - S705SW - S713SB - S709SW - S709S - S711SB - S765S - S767S - S991SB - S719SB - S717SB



Cromo	29 02 V748CM
Polished Nickel PVD	29 95 V748CM
Matt Gun Metal PVD	29 P5 V748CM
Matt British Gold PVD	29 P6 V748CM
Matt Copper PVD	29 P9 V748CM
Golden Look PVD	29 S9 V748CM

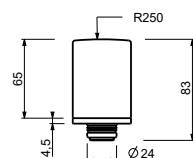

**V748CO**

**Maniglia VENEZIA by Venini in vetro di Murano - BICOLORE ROSSO AMBRA**

- supporto maniglia in ottone
- per articoli: S704SW - S704S - S705SW - S713SB - S709SW - S709S - S711SB - S765S - S767S - S991SB - S719SB - S717SB



Cromo	29 02 V748CO
Polished Nickel PVD	29 95 V748CO
Matt Gun Metal PVD	29 P5 V748CO
Matt British Gold PVD	29 P6 V748CO
Matt Copper PVD	29 P9 V748CO
Golden Look PVD	29 S9 V748CO

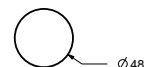
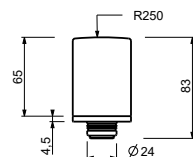

**F948CP**

**Maniglia VENEZIA by Venini in vetro di Murano - FILIGRANA BIANCA**

- supporto maniglia in ottone
- per articoli: S704SW - S704S - S705SW - S713SB - S709SW - S709S - S711SB - S765S - S767S - S991SB - S719SB - S717SB



Cromo	29 02 F948CP
Polished Nickel PVD	29 95 F948CP
Matt Gun Metal PVD	29 P5 F948CP
Matt British Gold PVD	29 P6 F948CP
Matt Copper PVD	29 P9 F948CP
Golden Look PVD	29 S9 F948CP

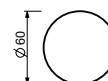
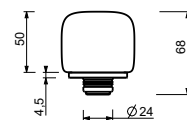

**F948CQ****Maniglia VENEZIA by Venini in vetro di Murano - FILIGRANA NERA**

- supporto maniglia in ottone
- per articoli: S704SW - S704S - S705SW - S713SB - S709SW - S709S - S711SB - S765S - S767S - S991SB - S719SB - S717SB

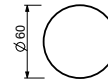
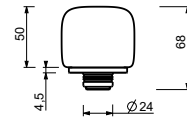

Cromo	29 02 F948CQ
Polished Nickel PVD	29 95 F948CQ
Matt Gun Metal PVD	29 P5 F948CQ
Matt British Gold PVD	29 P6 F948CQ
Matt Copper PVD	29 P9 F948CQ
Golden Look PVD	29 S9 F948CQ

### S704SW

lead $\phi$ free



#### Gruppo lavabo 3 fori

- interasse bocca 17,5 cm
- senza maniglie
- limitatore di portata 5 l/min a 3 bar
- vitone ceramico 90°
- flessibili di alimentazione
- SENZA SCARICO

**N.B. Maniglie da ordinare separatamente, consultare la sezione "Maniglie"**

Cromo	29 02 S704SW
Polished Nickel PVD	29 95 S704SW
Matt Gun Metal PVD	29 P5 S704SW
Matt British Gold PVD	29 P6 S704SW
Matt Copper PVD	29 P9 S704SW
Golden Look PVD	29 S9 S704SW

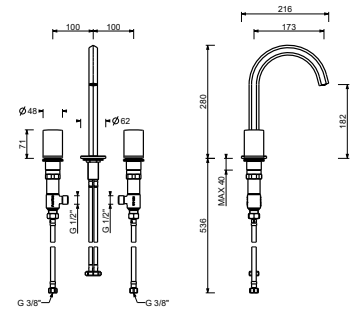

### S704S

lead $\phi$ free



#### Gruppo lavabo 3 fori

- interasse bocca 17,5 cm
- senza maniglie
- limitatore di portata 5 l/min a 3 bar
- vitone ceramico 90°
- flessibili di alimentazione
- CON SCARICO a pressione

**N.B. Maniglie da ordinare separatamente, consultare la sezione "Maniglie"**

Cromo	29 02 S704S
Polished Nickel PVD	29 95 S704S
Matt Gun Metal PVD	29 P5 S704S
Matt British Gold PVD	29 P6 S704S
Matt Copper PVD	29 P9 S704S
Golden Look PVD	29 S9 S704S

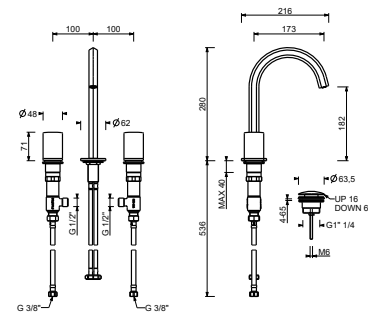

### S705SW

lead $\phi$ free



#### Gruppo lavabo alto 3 fori

- interasse bocca 17,5 cm
- senza maniglie
- limitatore di portata 5 l/min a 3 bar
- vitone ceramico 90°
- flessibili di alimentazione
- SENZA SCARICO

**N.B. Maniglie da ordinare separatamente, consultare la sezione "Maniglie"**

Cromo	29 02 S705SW
Polished Nickel PVD	29 95 S705SW
Matt Gun Metal PVD	29 P5 S705SW
Matt British Gold PVD	29 P6 S705SW
Matt Copper PVD	29 P9 S705SW
Golden Look PVD	29 S9 S705SW

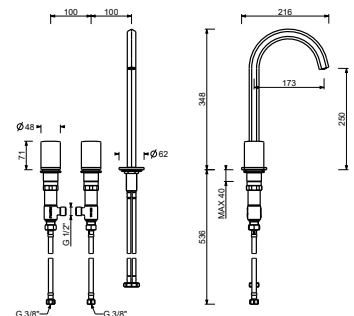

lead  free**Gruppo lavabo da parete**

- interasse bocca 20 cm
- senza maniglie
- limitatore di portata 5 l/min a 3 bar
- vitone ceramico 90°
- ingressi da 1/2"
- SENZA SCARICO

**N.B. Maniglie da ordinare separatamente, consultare la sezione "Maniglie"**

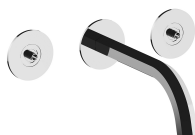
**S713SB****Parte esterna**

Cromo	29 02 S713SB
Polished Nickel PVD	29 95 S713SB
Matt Gun Metal PVD	29 P5 S713SB
Matt British Gold PVD	29 P6 S713SB
Matt Copper PVD	29 P9 S713SB
Golden Look PVD	29 S9 S713SB

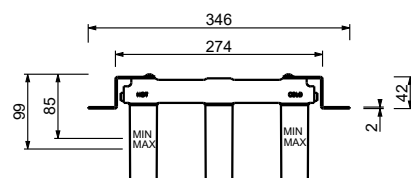
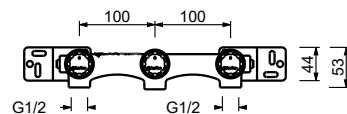
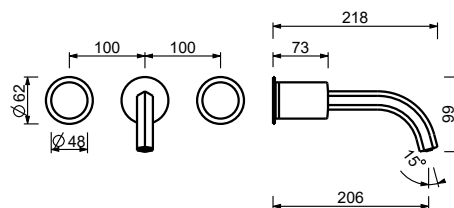
**R010A****Parte da incasso**

44 00 R010A



**S709SW**



**Gruppo bidet 3 fori**

- interasse bocca 12 cm
- senza maniglie
- limitatore di portata 5 l/min a 3 bar
- vitone ceramico 90°
- aeratore snodato
- flessibili di alimentazione
- SENZA SCARICO

**N.B. Maniglie da ordinare separatamente, consultare la sezione "Maniglie"**

Cromo	29 02 S709SW
Polished Nickel PVD	29 95 S709SW
Matt Gun Metal PVD	29 P5 S709SW
Matt British Gold PVD	29 P6 S709SW
Matt Copper PVD	29 P9 S709SW
Golden Look PVD	29 S9 S709SW

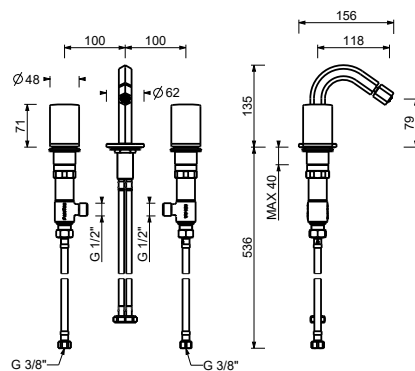

**S709S**



**Gruppo bidet 3 fori**

- interasse bocca 12 cm
- senza maniglie
- limitatore di portata 5 l/min a 3 bar
- vitone ceramico 90°
- aeratore snodato
- flessibili di alimentazione
- CON SCARICO a pressione

**N.B. Maniglie da ordinare separatamente, consultare la sezione "Maniglie"**

Cromo	29 02 S709S
Polished Nickel PVD	29 95 S709S
Matt Gun Metal PVD	29 P5 S709S
Matt British Gold PVD	29 P6 S709S
Matt Copper PVD	29 P9 S709S
Golden Look PVD	29 S9 S709S

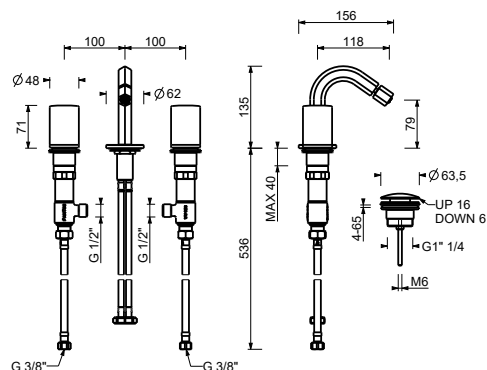

**Gruppo bidet monoforo**

- interasse bocca 12 cm
- senza maniglie
- comandi remoti a parete
- limitatore di portata 5 l/min a 3 bar
- vitone ceramico 90°
- aeratore snodato
- flessibili di alimentazione
- CON SCARICO a pressione

**N.B. Maniglie da ordinare separatamente, consultare la sezione "Maniglie"**

**S711SB**



**Parte esterna**

Cromo	29 02 S711SB
Polished Nickel PVD	29 95 S711SB
Matt Gun Metal PVD	29 P5 S711SB
Matt British Gold PVD	29 P6 S711SB
Matt Copper PVD	29 P9 S711SB
Golden Look PVD	29 S9 S711SB

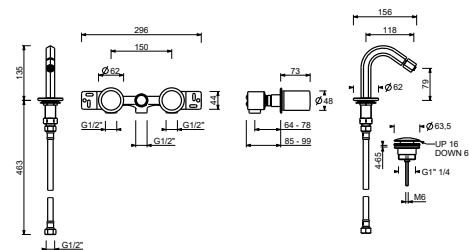

**R011A**



**Parte da incasso**

44 00 R011A

**Idrospray**

- per igiene personale
- miscelatore doccia incluso
- presa acqua con supporto per doccetta
- con rosoni
- flessibile in ottone 120 cm
- ingresso da 1/2"

**N.B. elenco completo delle finiture nella sezione articoli vari in fondo al listino**

**E857B**



**Parte esterna**

Cromo	50 02 E857B
Polished Nickel PVD	50 95 E857B
Matt Gun Metal PVD	50 P5 E857B
Matt British Gold PVD	50 P6 E857B
Matt Copper PVD	50 P9 E857B
Golden Look PVD	50 S9 E857B

**M111A**

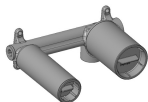

**Parte da incasso**

44 00 M111A

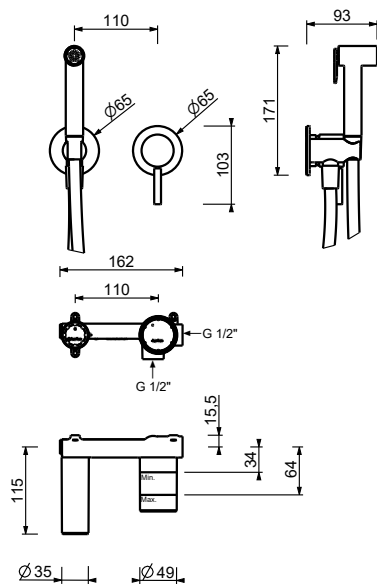

**W291**



**Idroscopino**

- per pulizia WC
- presa acqua con supporto per doccetta
- rubinetto di arresto
- rosone tondo
- flessibile in ottone 120 cm

**N.B. elenco completo delle finiture nella sezione articoli vari in fondo al listino**

Cromo	91 02 W291
Polished Nickel PVD	91 95 W291
Matt Gun Metal PVD	91 P5 W291
Matt British Gold PVD	91 P6 W291
Matt Copper PVD	91 P9 W291
Golden Look PVD	91 S9 W291

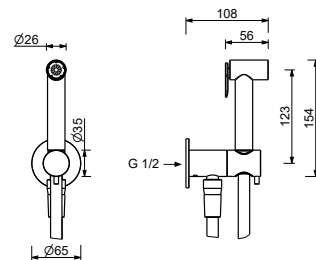

CARTUCCIA TERMOSTATICA

**Miscelatore doccia incasso**

*\_ingressi da 1/2"*



**G423B+M523A**

2 uscite



**G423B+M623A**

2 uscite

**Miscelatore doccia incasso**

*\_ingressi da 3/4"*



**H572B+H572A**

2 uscite

pulsanti ON/OFF  
con regolazione di portata

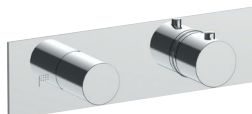

**G572B+D372A**

2 uscite

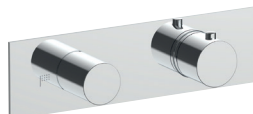

**G573B+D373A**

3 uscite



**H700B+H500A**



**H790B+H590A**

rubinetto di arresto  
pulsante ON/OFF  
con regolazione di portata  
**serigrafia soffione**



**H791B+H590A**

rubinetto di arresto  
pulsante ON/OFF  
con regolazione di portata  
**serigrafia doccia**



**H792B+H590A**

rubinetto di arresto  
pulsante ON/OFF  
con regolazione di portata  
**serigrafia AUX**



**S991SB+D491A**

rubinetto di arresto

**Miscelatore termostatico doccia incasso 1/2"**

- maniglie
- con rosconi
- deviatore a rotazione a **2 uscite**
- ingressi da 1/2"
- isolamento acustico
- solo per montaggio verticale

**G423B****Parte esterna**

Cromo	87 02 G423B
Polished Nickel PVD	87 95 G423B
Matt Gun Metal PVD	87 P5 G423B
Matt British Gold PVD	87 P6 G423B
Matt Copper PVD	87 P9 G423B
Golden Look PVD	87 S9 G423B

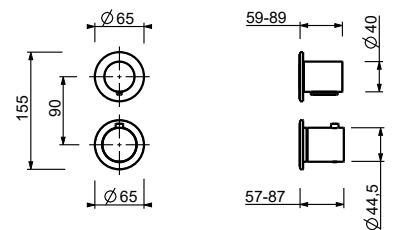
**M523A****Parte da incasso**

44 00 M523A

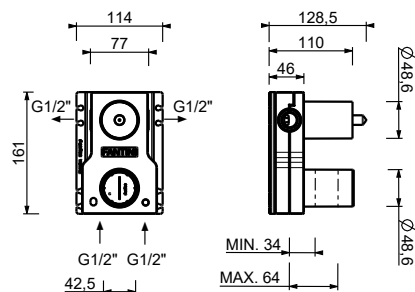
**Miscelatore termostatico doccia incasso 1/2"**

- maniglie
- con rosconi
- deviatore a rotazione a **2 uscite**
- ingressi da 1/2"
- isolamento acustico
- solo per montaggio orizzontale

**G423B****Parte esterna**

Cromo	87 02 G423B
Polished Nickel PVD	87 95 G423B
Matt Gun Metal PVD	87 P5 G423B
Matt British Gold PVD	87 P6 G423B
Matt Copper PVD	87 P9 G423B
Golden Look PVD	87 S9 G423B

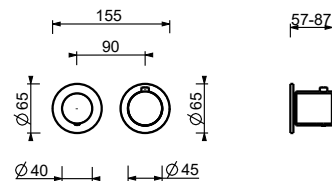
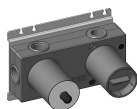
**M623A****Parte da incasso**

44 00 M623A

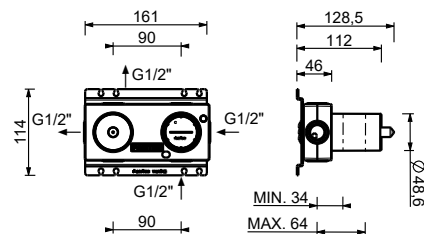

**Miscelatore termostatico doccia incasso 3/4"**

- maniglia
- pulsanti ON/OFF con regolazione di portata
- isolamento acustico
- solo per montaggio orizzontale
- ingressi da 3/4"
- **2 uscite** da 1/2"

**H572B****Parte esterna**

Cromo	87 02 H572B
Polished Nickel PVD	87 95 H572B
Matt Gun Metal PVD	87 P5 H572B
Matt British Gold PVD	87 P6 H572B
Matt Copper PVD	87 P9 H572B
Golden Look PVD	87 S9 H572B

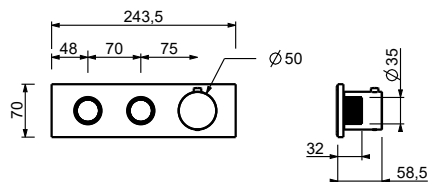
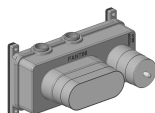
**H572A****Parte da incasso**

44 00 H572A

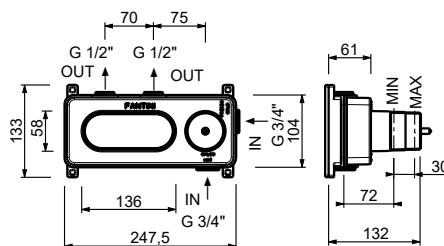
**Miscelatore termostatico doccia incasso 3/4"**

- maniglie
- deviatore a rotazione con chiusura a **2 uscite**
- solo per montaggio orizzontale
- ingressi da 3/4"

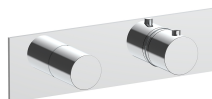
**G572B****Parte esterna**

Cromo	87 02 G572B
Polished Nickel PVD	87 95 G572B
Matt Gun Metal PVD	87 P5 G572B
Matt British Gold PVD	87 P6 G572B
Matt Copper PVD	87 P9 G572B
Golden Look PVD	87 S9 G572B

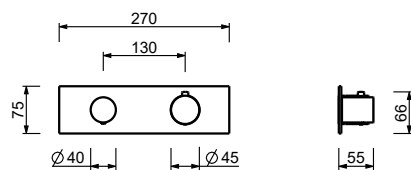
**D372A****Parte da incasso**

19 00 D372A

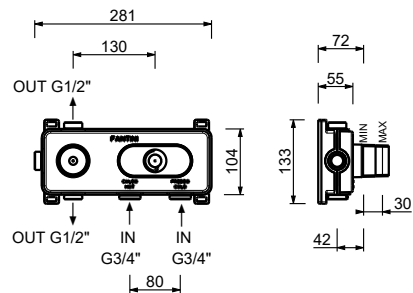

**Miscelatore termostatico doccia incasso 3/4"**

- maniglie
- deviatore a rotazione con chiusura a **3 uscite**
- solo per montaggio orizzontale
- ingressi da 3/4"

**G573B****Parte esterna**

Cromo	87 02 G573B
Polished Nickel PVD	87 95 G573B
Matt Gun Metal PVD	87 P5 G573B
Matt British Gold PVD	87 P6 G573B
Matt Copper PVD	87 P9 G573B
Golden Look PVD	87 S9 G573B

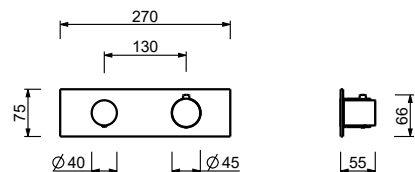
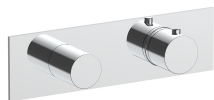
**D373A****Parte da incasso**

19 00 D373A

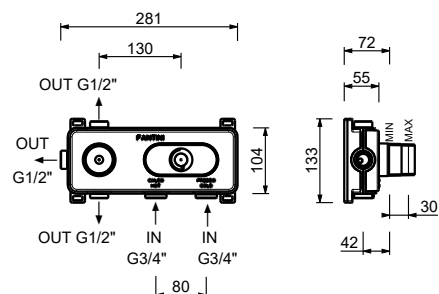
**Miscelatore termostatico doccia incasso 3/4"**

- maniglia
- ingressi da 1/2"
- isolamento acustico
- senza rubinetto di arresto **da ordinare separatamente**

**N.B. Il miscelatore deve essere sempre ordinato con il rubinetto di arresto o con i deviatori con chiusura**

**H700B****Parte esterna**

Cromo	87 02 H700B
Polished Nickel PVD	87 95 H700B
Matt Gun Metal PVD	87 P5 H700B
Matt British Gold PVD	87 P6 H700B
Matt Copper PVD	87 P9 H700B
Golden Look PVD	87 S9 H700B

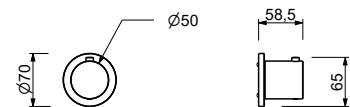
**H500A****Parte da incasso**

44 00 H500A

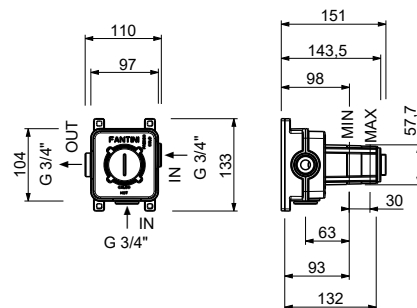

**Rubinetto di arresto**

- pulsante ON/OFF con regolazione di portata **serigrafia soffione**
- isolamento acustico
- per montaggio orizzontale e verticale
- ingressi da 1/2"

**H790B****Parte esterna**

Cromo	87 02 H790B
Polished Nickel PVD	87 95 H790B
Matt Gun Metal PVD	87 P5 H790B
Matt British Gold PVD	87 P6 H790B
Matt Copper PVD	87 P9 H790B
Golden Look PVD	87 S9 H790B

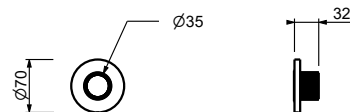
**H590A****Parte da incasso**

44 00 H590A

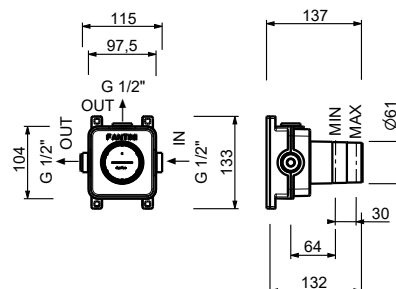
**Rubinetto di arresto**

- pulsante ON/OFF con regolazione di portata **serigrafia doccetta**
- isolamento acustico
- per montaggio orizzontale e verticale
- ingressi da 1/2"

**H791B****Parte esterna**

Cromo	87 02 H791B
Polished Nickel PVD	87 95 H791B
Matt Gun Metal PVD	87 P5 H791B
Matt British Gold PVD	87 P6 H791B
Matt Copper PVD	87 P9 H791B
Golden Look PVD	87 S9 H791B

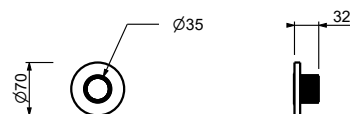
**H590A****Parte da incasso**

44 00 H590A

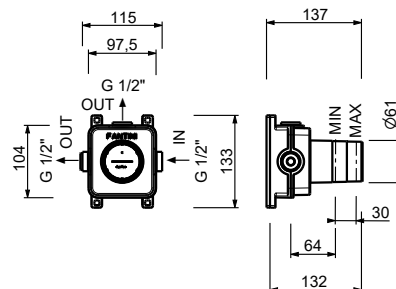

**Rubinetto di arresto**

- pulsante ON/OFF con regolazione di portata **serigrafia**

**AUX**

- isolamento acustico
- per montaggio orizzontale e verticale
- ingressi da 1/2"

**H792B****Parte esterna**

Cromo	87 02 H792B
Polished Nickel PVD	87 95 H792B
Matt Gun Metal PVD	87 P5 H792B
Matt British Gold PVD	87 P6 H792B
Matt Copper PVD	87 P9 H792B
Golden Look PVD	87 S9 H792B

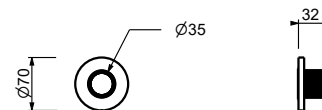
**H590A****Parte da incasso**

44 00 H590A

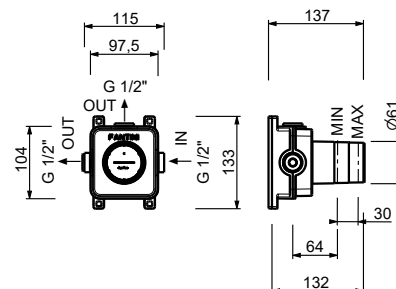
**Rubinetto di arresto 3/4"**

- senza maniglia
- vitone ceramico 90°
- ingressi da 3/4"

**N.B. Maniglia da ordinare separatamente, consultare la sezione "Maniglie"**

**S991SB****Parte esterna**

Cromo	29 02 S991SB
Polished Nickel PVD	29 95 S991SB
Matt Gun Metal PVD	29 P5 S991SB
Matt British Gold PVD	29 P6 S991SB
Matt Copper PVD	29 P9 S991SB
Golden Look PVD	29 S9 S991SB

**D491A****Parte da incasso**

19 00 D491A

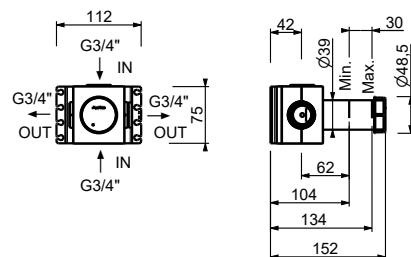

**W269****OPTIONAL - Sistema Easy fix per rubinetto arresto ON/OFF**

piastra e connessioni :

- per montaggio facilitato orizzontale o verticale termostatici
- per montaggio art. H500A / H590A - **1 uscita**
- per montaggio H500A / H590A (2 PZ) - **2 uscite**

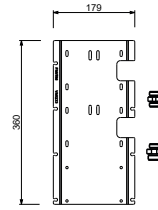
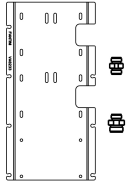
**ESEMPI DI COMBINAZIONI - 1 USCITA****ESEMPI DI COMBINAZIONI - 2 USCITE**

91 00 W269

**W270****OPTIONAL - Sistema Easy fix per rubinetto arresto ON/OFF**

piastra e connessioni :

- per montaggio facilitato orizzontale o verticale termostatici
- per montaggio H500A / H590A (3 PZ) - **3 uscite**

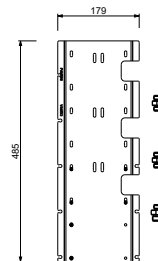
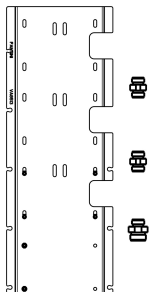
**ESEMPI DI COMBINAZIONI - 3 USCITE**

91 00 W270

**W275****OPTIONAL - Sistema Easy fix per RUBINETTO ARRESTO 3/4"**

piastra e connessioni :

- per montaggio facilitato orizzontale o verticale termostatici
- per montaggio art. H500A / D491A - **1 uscita**
- per montaggio H500A / D491A (2 PZ) - **2 uscite**

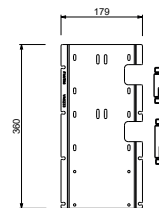
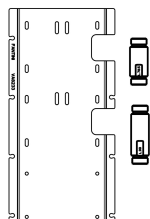
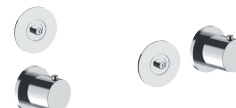
**ESEMPI DI COMBINAZIONI - 1 USCITA****ESEMPI DI COMBINAZIONI - 2 USCITE**

91 00 W275

**W276****OPTIONAL - Sistema Easy fix per RUBINETTO ARRESTO 3/4"**

piastra e connessioni :

- per montaggio facilitato orizzontale o verticale termostatici
- per montaggio H500A / D491A (3 PZ) - **3 uscite**

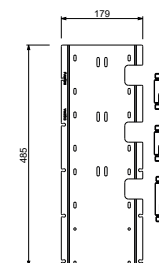
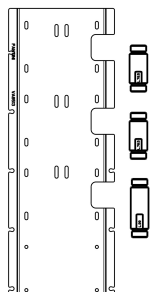
**ESEMPI DI COMBINAZIONI - 3 USCITE**

91 00 W276

8083

**Soffione a pioggia**

- Ø 24 cm
- materiale di base: acciaio
- limitatore di portata 12 l/min a 3 bar
- sistema anticalcare
- ingresso da 1/2"
- valvola di non ritorno

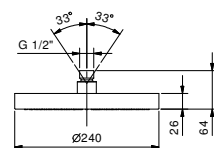
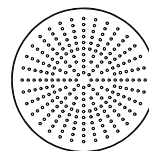
**N.B. Condizioni necessarie per il corretto funzionamento:****Portata min.: 10 l/min**

Cromo	86 02 8083
Polished Nickel PVD	86 95 8083
Matt Gun Metal PVD	86 P5 8083
Matt British Gold PVD	86 P6 8083
Matt Copper PVD	86 P9 8083
Golden Look PVD	86 S9 8083

8157

**Soffione a pioggia**

- Ø 25 cm
- materiale di base: ABS
- limitatore di portata 9 l/min a 3 bar
- sistema anticalcare
- ingresso da 1/2"
- valvola di non ritorno

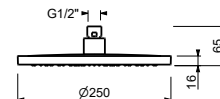
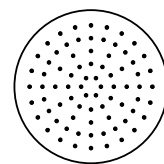
**N.B. Condizioni necessarie per il corretto funzionamento:****Portata min.: 10 l/min**

Cromo	86 02 8157
-------	------------

8159

**Soffione a pioggia**

- Ø 25 cm
- materiale di base: ottone
- limitatore di portata 9 l/min a 3 bar
- sistema anticalcare
- ingresso da 1/2"
- valvola di non ritorno

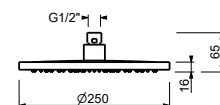
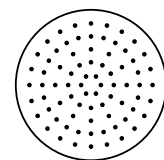
**N.B. Condizioni necessarie per il corretto funzionamento:****Portata min.: 10 l/min**

Cromo	86 02 8159
Polished Nickel PVD	86 95 8159
Matt Gun Metal PVD	86 P5 8159
Matt British Gold PVD	86 P6 8159
Matt Copper PVD	86 P9 8159
Golden Look PVD	86 S9 8159

**K073****Soffione a pioggia**

- ACQUAFIT
- Funzioni acqua:**
- funzione 1: 240 ugelli anticalcare **pioggia concentrata al centro**
- Ø 30 cm
- materiale di base: acciaio
- valvola di non ritorno
- limitatore di portata 14 l/min a 3 bar
- sistema anticalcare
- ingresso da 1/2"

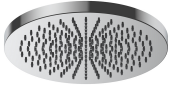

**N.B. Condizioni necessarie per il corretto funzionamento:  
Portata min.: 12 l/min**

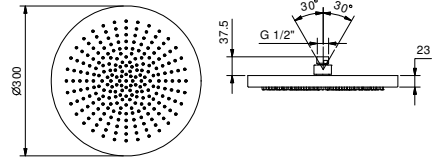

Acciaio lucido	79 38 K073
Polished Nickel PVD	79 95 K073
Matt Gun Metal PVD	79 P5 K073
Matt British Gold PVD	79 P6 K073
Matt Copper PVD	79 P9 K073
Golden Look PVD	79 S9 K073

**8084****Soffione a pioggia**

- Ø 36 cm
- materiale di base: acciaio
- sistema anticalcare
- ingresso da 1/2"
- valvola di non ritorno

**N.B. Condizioni necessarie per il corretto  
funzionamento: Portata min.: 15 l/min**

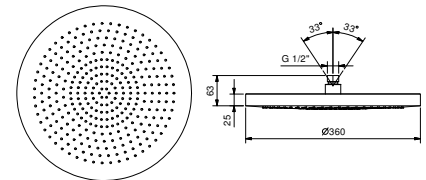

Cromo	86 02 8084
-------	------------

**Soffione doppio**

- pioggia
- cascata
- materiale di base: ottone
- per installazione a parete
- limitatore di portata 17 l/min a 3 bar
- sistema anticalcare
- ingresso da 1/2"
- portata minima 12 l/min

**N.B. Condizioni necessarie per il corretto funzionamento:**

**Portata min.: 12 l/min**

**8035B****Parte esterna**

Cromo	86 02 8035B
Polished Nickel PVD	86 95 8035B
Matt Gun Metal PVD	86 P5 8035B
Matt British Gold PVD	86 P6 8035B
Matt Copper PVD	86 P9 8035B
Golden Look PVD	86 S9 8035B

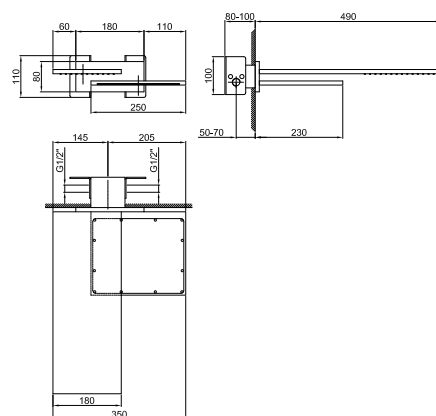
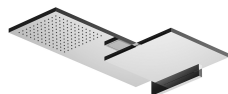
**8035A****Parte da incasso**

86 00 8035A



**Soffione a pioggia**

- materiale di base: ottone
- per installazione a parete
- limitatore di portata 17 l/min a 3 bar
- sistema anticalcare
- ingresso da 1/2"
- portata minima 10 l/min

**N.B. Condizioni necessarie per il corretto funzionamento:****Portata min.: 10 l/min****8036B****Parte esterna**

Cromo	86 02 8036B
Polished Nickel PVD	86 95 8036B
Matt Gun Metal PVD	86 P5 8036B
Matt British Gold PVD	86 P6 8036B
Matt Copper PVD	86 P9 8036B
Golden Look PVD	86 S9 8036B

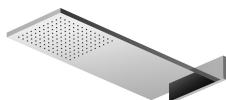
**8036A****Parte da incasso**

86 00 8036A

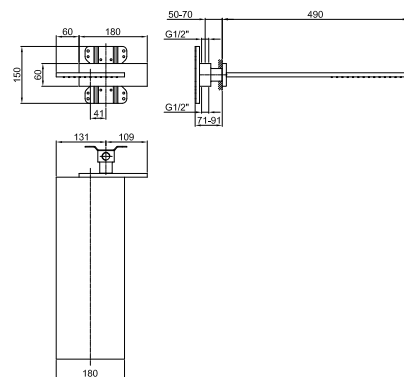
**8027****Braccio doccia**

- lunghezza 30 cm
- rosone tondo
- per installazione a parete
- ingresso da 1/2"

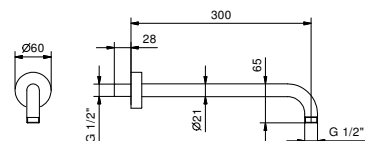

Cromo	86 02 8027
Polished Nickel PVD	86 95 8027
Matt Gun Metal PVD	86 P5 8027
Matt British Gold PVD	86 P6 8027
Matt Copper PVD	86 P9 8027
Golden Look PVD	86 S9 8027

**OPTIONAL: Parte da incasso per cartongesso****W046**

91 00 W046

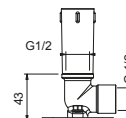

8137

**Braccio doccia**

- lunghezza 35 cm
- rosone tondo
- per installazione a parete
- ingresso da 1/2"

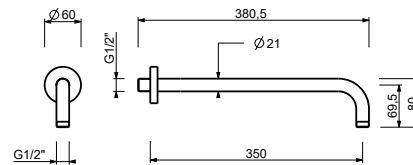

Cromo	86 02 8137
Polished Nickel PVD	86 95 8137
Matt Gun Metal PVD	86 P5 8137
Matt British Gold PVD	86 P6 8137
Matt Copper PVD	86 P9 8137
Golden Look PVD	86 S9 8137

**OPTIONAL: Parte da incasso per cartongesso****W046**

91 00 W046

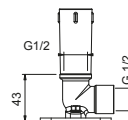

8124

**Braccio doccia**

- lunghezza 40 cm
- rosone tondo
- per installazione a parete
- ingresso da 1/2"

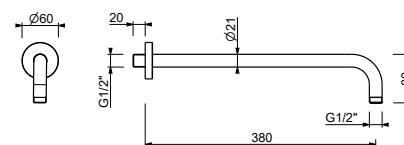

Cromo	86 02 8124
Polished Nickel PVD	86 95 8124
Matt Gun Metal PVD	86 P5 8124
Matt British Gold PVD	86 P6 8124
Matt Copper PVD	86 P9 8124
Golden Look PVD	86 S9 8124

**OPTIONAL: Parte da incasso per cartongesso****W046**

91 00 W046

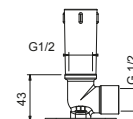

8028

**Braccio doccia**

- lunghezza 45 cm
- rosone tondo
- per installazione a parete
- ingresso da 1/2"

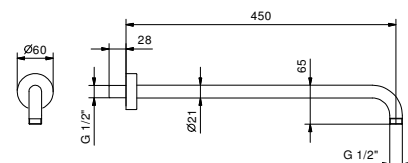

Cromo	86 02 8028
Polished Nickel PVD	86 95 8028
Matt Gun Metal PVD	86 P5 8028
Matt British Gold PVD	86 P6 8028
Matt Copper PVD	86 P9 8028
Golden Look PVD	86 S9 8028

**OPTIONAL: Parte da incasso per cartongesso****W046**

91 00 W046

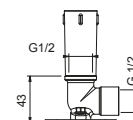

9231

**Braccio doccia**

- lunghezza 30 cm
- rosone tondo
- per installazione a parete
- ingresso da 1/2"



Cromo	86 02 9231
Polished Nickel PVD	86 95 9231
Matt Gun Metal PVD	86 P5 9231
Matt British Gold PVD	86 P6 9231
Matt Copper PVD	86 P9 9231
Golden Look PVD	86 S9 9231

**OPTIONAL: Parte da incasso per cartongesso****W046**

91 00 W046

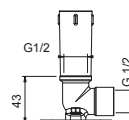
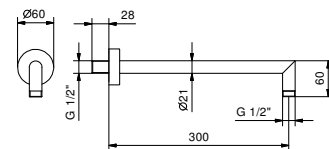

8011

**Braccio doccia**

- lunghezza 45 cm
- rosone tondo
- per installazione a parete
- ingresso da 1/2"



Cromo	86 02 8011
Polished Nickel PVD	86 95 8011
Matt Gun Metal PVD	86 P5 8011
Matt British Gold PVD	86 P6 8011
Matt Copper PVD	86 P9 8011
Golden Look PVD	86 S9 8011

**OPTIONAL: Parte da incasso per cartongesso****W046**

91 00 W046

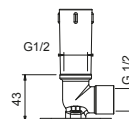
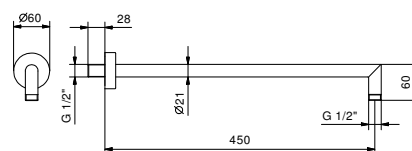

8121

**Braccio doccia**

- lunghezza 10 cm
- rosone tondo
- per installazione a soffitto
- ingresso da 1/2"



Cromo	86 02 8121
Polished Nickel PVD	86 95 8121
Matt Gun Metal PVD	86 P5 8121
Matt British Gold PVD	86 P6 8121
Matt Copper PVD	86 P9 8121
Golden Look PVD	86 S9 8121

**OPTIONAL: Parte da incasso per cartongesso****W046**

91 00 W046

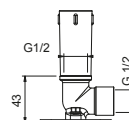
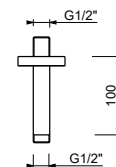

9236

**Braccio doccia**

- lunghezza 25 cm
- rosone tondo
- per installazione a soffitto
- ingresso da 1/2"

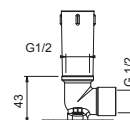
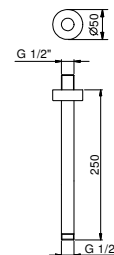

Cromo	86 02 9236
Polished Nickel PVD	86 95 9236
Matt Gun Metal PVD	86 P5 9236
Matt British Gold PVD	86 P6 9236
Matt Copper PVD	86 P9 9236
Golden Look PVD	86 S9 9236

**OPTIONAL: Parte da incasso per cartongesso****W046** 91 00 W046

9237

**Braccio doccia**

- lunghezza 45 cm
- rosone tondo
- per installazione a soffitto
- ingresso da 1/2"

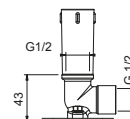
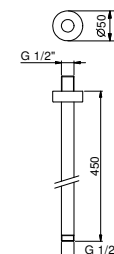

Cromo	86 02 9237
Polished Nickel PVD	86 95 9237
Matt Gun Metal PVD	86 P5 9237
Matt British Gold PVD	86 P6 9237
Matt Copper PVD	86 P9 9237
Golden Look PVD	86 S9 9237

**OPTIONAL: Parte da incasso per cartongesso****W046** 91 00 W046

8158

**Completo doccia**

- rosone tondo  $\varnothing$  70 mm spessore 7,5
- doccetta FIT
- presa acqua con supporto per doccetta
- flessibile PVC 150 cm
- ingresso da 1/2"



Cromo	86 02 8158
Polished Nickel PVD	86 95 8158
Matt Gun Metal PVD	86 P5 8158
Matt British Gold PVD	86 P6 8158
Matt Copper PVD	86 P9 8158
Golden Look PVD	86 S9 8158

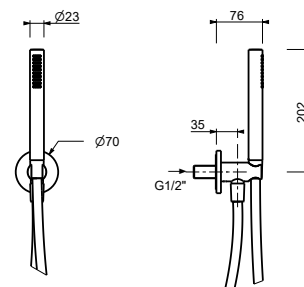

5943

**Completo doccia**

- rosone tondo Ø 65 mm spessore 4
- doccetta VENEZIA
- presa acqua con supporto per doccetta
- flessibile in ottone 150 cm
- flessibile in ottone 140 cm nelle versioni in PVD
- ingresso da 1/2"



Cromo	29 02 5943
Polished Nickel PVD	29 95 5943
Matt Gun Metal PVD	29 P5 5943
Matt British Gold PVD	29 P6 5943
Matt Copper PVD	29 P9 5943
Golden Look PVD	29 S9 5943

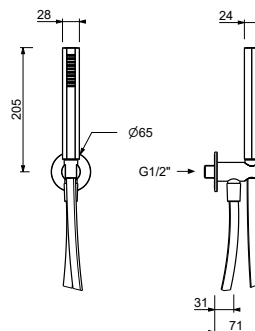

5944

**Completo doccia**

- rosone tondo Ø 65 mm spessore 4
- doccetta FIT
- presa acqua con supporto per doccetta
- flessibile in ottone 150 cm
- flessibile in ottone 140 cm nelle versioni in PVD
- ingresso da 1/2"



Cromo	29 02 5944
Polished Nickel PVD	29 95 5944
Matt Gun Metal PVD	29 P5 5944
Matt British Gold PVD	29 P6 5944
Matt Copper PVD	29 P9 5944
Golden Look PVD	29 S9 5944

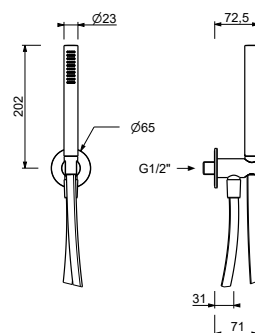

9849

**Doccetta**

- VENEZIA
- limitatore di portata 9 l/min
- sistema anticalcare
- valvola di non ritorno



Cromo	90 02 9849
Polished Nickel PVD	90 95 9849
Matt Gun Metal PVD	90 P5 9849
Matt British Gold PVD	90 P6 9849
Matt Copper PVD	90 P9 9849
Golden Look PVD	90 S9 9849

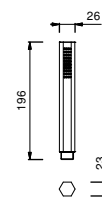

8783

**Doccetta**

- FIT
- materiale di base: ottone
- limitatore di portata 9 l/min
- sistema anticalcare
- valvola di non ritorno



Cromo	90 02 8783
Polished Nickel PVD	90 95 8783
Matt Gun Metal PVD	90 P5 8783
Matt British Gold PVD	90 P6 8783
Matt Copper PVD	90 P9 8783
Golden Look PVD	90 S9 8783

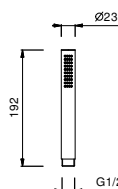

9248

**Soffione laterale**

- materiale di base: ottone
- orientabile
- sistema anticalcare
- ingresso da 1/2"

**N.B. Condizioni necessarie per il corretto funzionamento:  
Portata min.: 12 l/min**

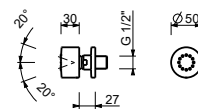

Cromo	86 02 9248
Polished Nickel PVD	86 95 9248
Matt Gun Metal PVD	86 P5 9248
Matt British Gold PVD	86 P6 9248
Matt Copper PVD	86 P9 9248
Golden Look PVD	86 S9 9248

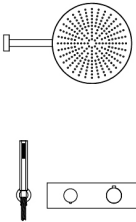
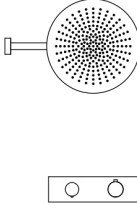
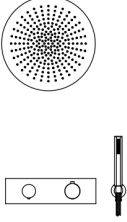
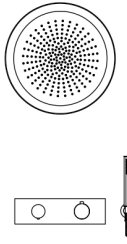
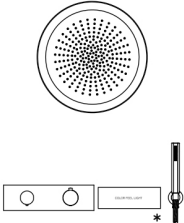
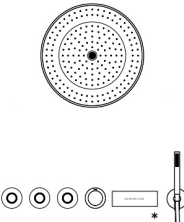
Composizione.1	Art.	Descrizione	Finiture	
	8027	Braccio doccia	02	Cromo
	8083	Soffione a pioggia	95	Polished Nickel PVD
	G572B+D372A	Miscelatore termostatico doccia incasso 3/4"	P5	Matt Gun Metal PVD
	5943	Completo doccia	P6	Matt British Gold PVD
			P9	Matt Copper PVD
			S9	Golden Look PVD
Composizione.2	Art.	Descrizione	Finiture	
	8027	Braccio doccia	02	Cromo
	K073	Soffione a pioggia	95	Polished Nickel PVD
	G572B+D372A	Miscelatore termostatico doccia incasso 3/4"	P5	Matt Gun Metal PVD
	5943	Completo doccia	P6	Matt British Gold PVD
			P9	Matt Copper PVD
			S9	Golden Look PVD
Composizione.3	Art.	Descrizione	Finiture	
	K072	Soffione a pioggia	02	Cromo
	G572B+D372A	Miscelatore termostatico doccia incasso 3/4"	95	Polished Nickel PVD
	5943	Completo doccia	P5	Matt Gun Metal PVD
			P6	Matt British Gold PVD
			P9	Matt Copper PVD
			S9	Golden Look PVD
Composizione.4	Art.	Descrizione	Finiture	
	K062	Soffione a pioggia	02	Cromo
	G572B+D372A	Miscelatore termostatico doccia incasso 3/4"	95	Polished Nickel PVD
	5943	Completo doccia	P5	Matt Gun Metal PVD
			P6	Matt British Gold PVD
			P9	Matt Copper PVD
			S9	Golden Look PVD
Composizione.5	Art.	Descrizione	Finiture	
	K061	Soffione multifunzione Dream	02	Cromo
	G572B+D372A	Miscelatore termostatico doccia incasso 3/4"	95	Polished Nickel PVD
	K101 OPT.	Tastiera di controllo touch	P5	Matt Gun Metal PVD
	5943	Completo doccia	P6	Matt British Gold PVD
			P9	Matt Copper PVD
			S9	Golden Look PVD
			<b>*optional</b>	
			K101	Tastiera di controllo touch
Composizione.6	Art.	Descrizione	Finiture	
	V561	Soffione multifunzione Dream	02	Cromo
	H700B+H500A	Miscelatore termostatico doccia incasso 3/4"	95	Polished Nickel PVD
	H790B+H590A	Rubinetto di arresto	P5	Matt Gun Metal PVD
	H791B+H590A	Rubinetto di arresto	P6	Matt British Gold PVD
	H792B+H590A	Rubinetto di arresto	P9	Matt Copper PVD
	K101 OPT.	Tastiera di controllo touch	S9	Golden Look PVD
	8158	Completo doccia	<b>*optional</b>	
			K101	Tastiera di controllo touch

VITONI CERAMICI DA 1/4 DI GIRO

**Miscelatore vasca incasso**

*\_ingressi da 1/2"  
\_interasse bocca 20 cm*



**S719SB+N019A**  
2 uscite

**Miscelatore vasca incasso**

*\_ingressi da 1/2"*



**S717SB+N017A**  
2 uscite

**Gruppo bordo vasca**

*\_ingressi da 3/4"  
\_interasse bocca 17,5 cm*



**S765S**  
2 uscite

**Gruppo bordo vasca**

*\_ingressi da 3/4"*



**S767S**  
2 uscite

**Miscelatore vasca da pavimento**

*\_ingressi da 1/2"  
\_interasse bocca 25 cm*



**N080B+R080A**  
2 uscite

**Bocca vasca incasso**

*\_interasse bocca 14,5 cm*



**5041B+5041A**



**5042B+5041A**

**Bocca vasca da parete**

*\_interasse bocca 20 cm*



**8315**

**Bocca vasca da pavimento**

*\_interasse bocca 24 cm*



**8418**

**Gruppo vasca incasso**

- interasse bocca 20 cm
- senza maniglie
- deviatore a rotazione a **2 uscite**
- doccetta VENEZIA
- presa acqua con supporto per doccetta
- flessibile in ottone 150 cm
- flessibile in ottone 140 cm nelle versioni in PVD
- vitone ceramico 90°
- ingressi da 1/2"

**N.B. Maniglie da ordinare separatamente, consultare la sezione "Maniglie"**

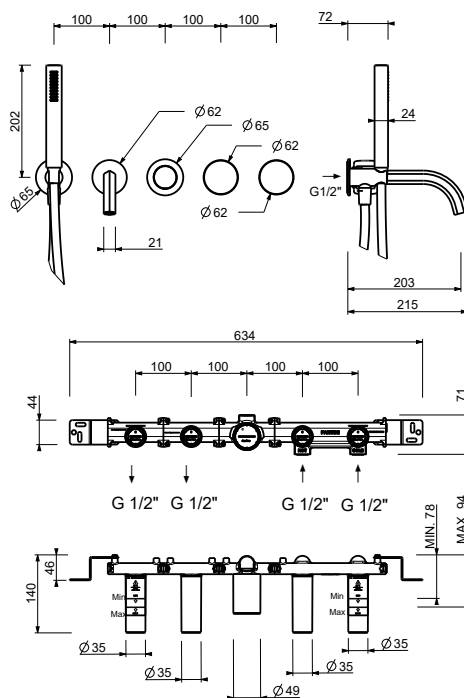

**S719SB**



**N019A**



**Parte esterna**

Cromo	29 02 S719SB
Polished Nickel PVD	29 95 S719SB
Matt Gun Metal PVD	29 P5 S719SB
Matt British Gold PVD	29 P6 S719SB
Matt Copper PVD	29 P9 S719SB
Golden Look PVD	29 S9 S719SB

**Parte da incasso**

44 00 N019A

**Prezzo totale**

- Cromo
- Polished Nickel PVD
- Matt Gun Metal PVD
- Matt British Gold PVD
- Matt Copper PVD
- Golden Look PVD

**Gruppo vasca incasso**

- senza maniglie
- senza bocca
- deviatore a rotazione a **2 uscite**
- doccetta VENEZIA
- presa acqua con supporto per doccetta
- flessibile in ottone 150 cm
- flessibile in ottone 140 cm nelle versioni in PVD
- vitone ceramico 90°
- ingressi da 1/2"

**N.B. Maniglie da ordinare separatamente, consultare la sezione "Maniglie"**

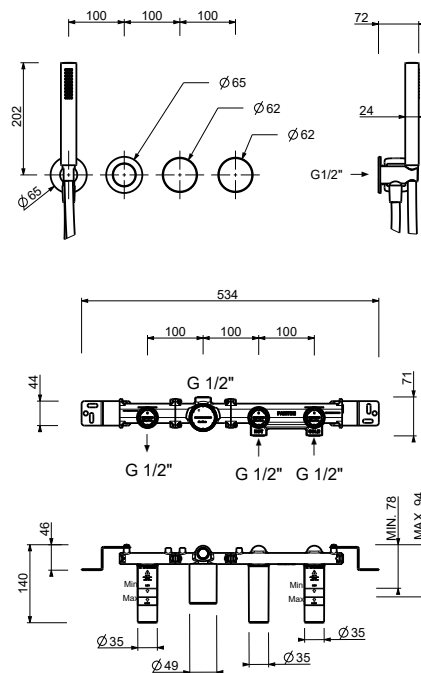

**S717SB**



**N017A**



**Parte esterna**

Cromo	29 02 S717SB
Polished Nickel PVD	29 95 S717SB
Matt Gun Metal PVD	29 P5 S717SB
Matt British Gold PVD	29 P6 S717SB
Matt Copper PVD	29 P9 S717SB
Golden Look PVD	29 S9 S717SB

**Parte da incasso**

44 00 N017A

**Prezzo totale**

- Cromo
- Polished Nickel PVD
- Matt Gun Metal PVD
- Matt British Gold PVD
- Matt Copper PVD
- Golden Look PVD

**S765S**

**Gruppo bordo vasca**

- interasse bocca 17,5 cm
- senza maniglie
- 5 fori
- deviatore a pulsante a **2 uscite**
- doccetta VENEZIA
- flessibile 150 cm
- vitone ceramico 90°
- ingressi da 3/4"
- flessibili di alimentazione



**N.B. Maniglie da ordinare separatamente, consultare la sezione "Maniglie"**

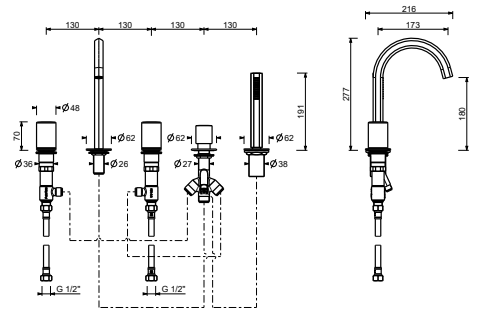

Cromo	29 02 S765S
Polished Nickel PVD	29 95 S765S
Matt Gun Metal PVD	29 P5 S765S
Matt British Gold PVD	29 P6 S765S
Matt Copper PVD	29 P9 S765S
Golden Look PVD	29 S9 S765S

**S767S**

**Gruppo bordo vasca**

- senza maniglie
- senza bocca
- 4 fori
- deviatore a pulsante a **2 uscite**
- doccetta VENEZIA
- flessibile 150 cm
- vitone ceramico 90°
- ingressi da 3/4"
- flessibili di alimentazione



**N.B. Maniglie da ordinare separatamente, consultare la sezione "Maniglie"**

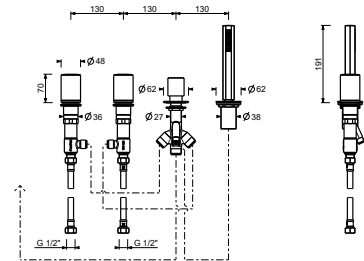

Cromo	29 02 S767S
Polished Nickel PVD	29 95 S767S
Matt Gun Metal PVD	29 P5 S767S
Matt British Gold PVD	29 P6 S767S
Matt Copper PVD	29 P9 S767S
Golden Look PVD	29 S9 S767S

**Miscelatore vasca da pavimento**

- interasse bocca 25 cm
- maniglia
- maniglia apri/chiedi con regolazione portata e temperatura doccia
- doccetta VENEZIA
- supporto doccetta
- flessibile PVC 150 cm
- ingressi da 1/2"
- su colonna

**N080B**



**R080A**



**Parte esterna**

Cromo	29 02 N080B
Polished Nickel PVD	29 95 N080B
Matt Gun Metal PVD	29 P5 N080B
Matt British Gold PVD	29 P6 N080B
Matt Copper PVD	29 P9 N080B
Golden Look PVD	29 S9 N080B

**Parte da incasso**

44 00 R080A

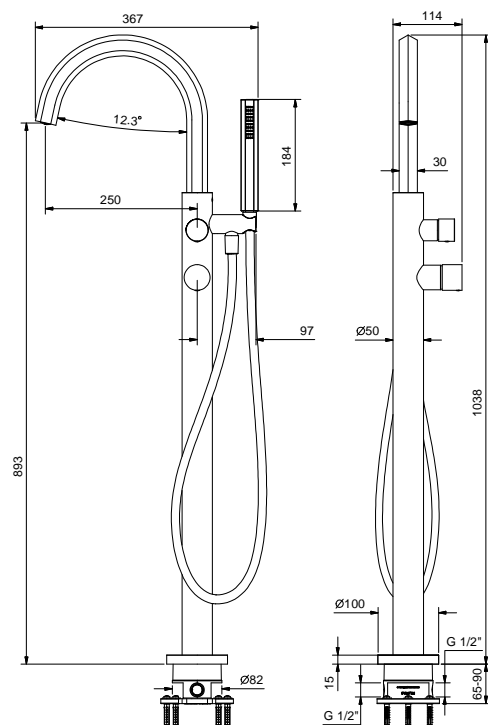

**Bocca vasca incasso**

- interasse bocca 14,5 cm
- versione destra
- cascata
- ingresso da 1/2"

5041B

**Parte esterna**

Cromo	31 02 5041B
Polished Nickel PVD	31 95 5041B
Matt Gun Metal PVD	31 P5 5041B
Matt British Gold PVD	31 P6 5041B
Matt Copper PVD	31 P9 5041B
Golden Look PVD	31 S9 5041B



5041A

**Parte da incasso**

31 00 5041A

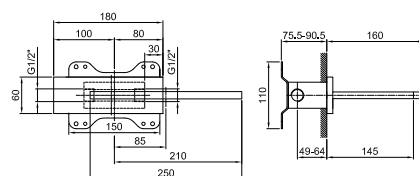

**Bocca vasca incasso**

- interasse bocca 14,5 cm
- versione sinistra
- cascata
- ingresso da 1/2"

5042B

**Parte esterna**

Cromo	31 02 5042B
Polished Nickel PVD	31 95 5042B
Matt Gun Metal PVD	31 P5 5042B
Matt British Gold PVD	31 P6 5042B
Matt Copper PVD	31 P9 5042B
Golden Look PVD	31 S9 5042B



5041A

**Parte da incasso**

31 00 5041A

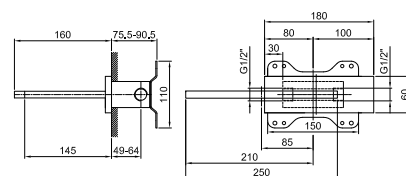

8315

**Bocca vasca da parete**

- interasse bocca 20 cm
- rosone tondo
- ingresso da 1/2"



Cromo	29 02 8315
Polished Nickel PVD	29 95 8315
Matt Gun Metal PVD	29 P5 8315
Matt British Gold PVD	29 P6 8315
Matt Copper PVD	29 P9 8315
Golden Look PVD	29 S9 8315

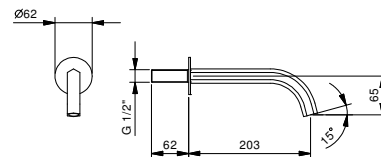

8418

**Bocca vasca da pavimento**

- interasse bocca 24 cm
- ingresso da 1/2"



Cromo	29 02 8418
Polished Nickel PVD	29 95 8418
Matt Gun Metal PVD	29 P5 8418
Matt British Gold PVD	29 P6 8418
Matt Copper PVD	29 P9 8418
Golden Look PVD	29 S9 8418

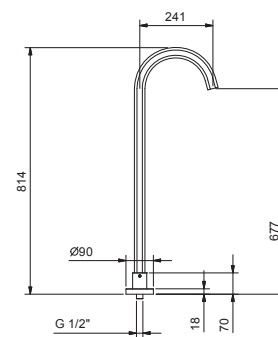

8434

**Scarico**

- 1" 1/4
- tappo a pressione
- per lavabi senza troppo pieno
- per lavabi con troppo pieno
- universale

**N.B. elenco completo delle finiture nella sezione articoli vari in fondo al listino**



Cromo	91 02 8434
Polished Nickel PVD	91 95 8434
Matt Gun Metal PVD	91 P5 8434
Matt British Gold PVD	91 P6 8434
Matt Copper PVD	91 P9 8434
Golden Look PVD	91 S9 8434

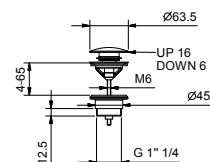

8435

**Scarico**

- 1" 1/4
- per lavabi senza troppo pieno
- per lavabi con troppo pieno
- uscita libera
- universale

**N.B. elenco completo delle finiture nella sezione articoli vari in fondo al listino**



Cromo	91 02 8435
Polished Nickel PVD	91 95 8435
Matt Gun Metal PVD	91 P5 8435
Matt British Gold PVD	91 P6 8435
Matt Copper PVD	91 P9 8435
Golden Look PVD	91 S9 8435

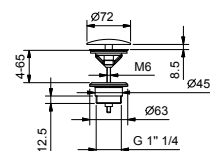

9234

**Sifone a bottiglia**

- 1" 1/4
- per lavabo

**N.B. elenco completo delle finiture nella sezione articoli vari in fondo al listino**



Cromo	91 02 9234
Polished Nickel PVD	91 95 9234
Matt Gun Metal PVD	91 P5 9234
Matt British Gold PVD	91 P6 9234
Matt Copper PVD	91 P9 9234
Golden Look PVD	91 S9 9234

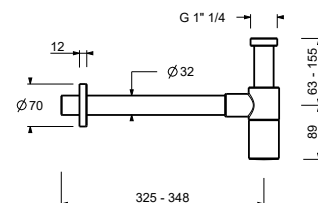

8364

**Coppia di rubinetti filtro**

- con chiusura
- filtro ispezionabile
- ingresso da 1/2"

**N.B. elenco completo delle finiture nella sezione articoli vari in fondo al listino**



Cromo	91 02 8364
Polished Nickel PVD	91 95 8364
Matt Gun Metal PVD	91 P5 8364
Matt British Gold PVD	91 P6 8364
Matt Copper PVD	91 P9 8364
Golden Look PVD	91 S9 8364

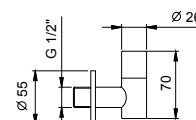

8402

**Placca di comando per cassette di scarico GEBERIT**

- materiale di base: acciaio
- comandi a rilievo
- con pulsanti tondi
- senza fissaggi a vista

**N.B. elenco completo delle finiture nella sezione articoli vari in fondo al listino**

**N.B. compatibile SOLO CON Geberit Sigma 8/Sigma 12**



Acciaio lucido	91 38 8402
Polished Nickel PVD	91 95 8402
Matt Gun Metal PVD	91 P5 8402
Matt British Gold PVD	91 P6 8402
Matt Copper PVD	91 P9 8402
Golden Look PVD	91 S9 8402

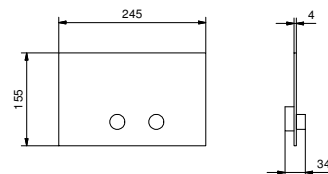

8403

**Placca di comando per cassette di scarico GEBERIT**

- materiale di base: acciaio
- comandi a filo
- con pulsanti quadri
- senza fissaggi a vista

**N.B. elenco completo delle finiture nella sezione articoli vari in fondo al listino**

**N.B. compatibile SOLO CON Geberit Sigma 8/Sigma 12**

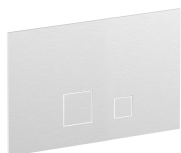

Acciaio lucido	91 38 8403
Polished Nickel PVD	91 95 8403
Matt Gun Metal PVD	91 P5 8403
Matt British Gold PVD	91 P6 8403
Matt Copper PVD	91 P9 8403
Golden Look PVD	91 S9 8403

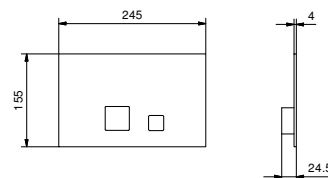

W216

**Placca di comando per cassette di scarico TECE**

- materiale di base: acciaio
- comandi a rilievo
- con pulsanti tondi
- profondità minima : consultare le istruzioni di montaggio
- senza fissaggi a vista

**N.B. elenco completo delle finiture nella sezione articoli vari in fondo al listino**

**N.B. compatibile SOLO CON Tecebox Octa II**



Acciaio lucido	91 38 W216
Polished Nickel PVD	91 95 W216
Matt Gun Metal PVD	91 P5 W216
Matt British Gold PVD	91 P6 W216
Matt Copper PVD	91 P9 W216
Golden Look PVD	91 S9 W216

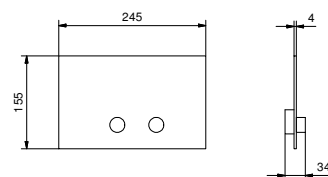

W001

**Colonna scarico vasca**

- CON SCARICO

**N.B. elenco completo delle finiture nella sezione articoli vari in fondo al listino**



Cromo	91 02 W001
Polished Nickel PVD	91 95 W001
Matt Gun Metal PVD	91 P5 W001
Matt British Gold PVD	91 P6 W001
Matt Copper PVD	91 P9 W001
Golden Look PVD	91 S9 W001

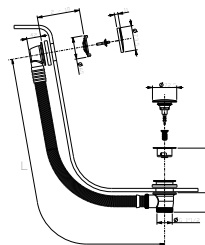

**W002****Colonna scarico vasca**

- erogazione dal troppo pieno
- CON SCARICO

**N.B. elenco completo delle finiture nella sezione articoli vari in fondo al listino**

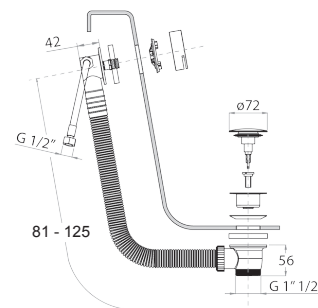

Cromo	91 02 W002
Polished Nickel PVD	91 95 W002
Matt Gun Metal PVD	91 P5 W002
Matt British Gold PVD	91 P6 W002
Matt Copper PVD	91 P9 W002
Golden Look PVD	91 S9 W002

**Z332****Kit per adattamento maniglie Venezia By Venini a prodotti Venezia**

- per articoli: N404SW - N404S - N504SW - N504S - N405SW - N409SW - N409S - N509SW - N509S



29 00 Z332

**Z333****Kit per adattamento maniglie Venezia By Venini a prodotti Venezia**

- per articoli: N013SB - N113SB - N458SWB+R011A - N411SB+R011A - N511SB+R011A



Cromo	29 02 Z333
Polished Nickel PVD	29 95 Z333
Matt Gun Metal PVD	29 P5 Z333
Matt British Gold PVD	29 P6 Z333
Matt Copper PVD	29 P9 Z333
Golden Look PVD	29 S9 Z333





**Fratelli Fantini Spa**

Pella (Novara), Italy - t. +39 0322 918411

[fantini@fantini.it](mailto:fantini@fantini.it) - [www.fantini.it](http://www.fantini.it)