

VENEZIA

BY VENINI

MANUAL TÉCNICO

VENEZIA by VENINI

design Matteo Thun & Antonio Rodriguez



95 S704S + 95 V748CN (2 PCS)

MANETAS	ipág. 399
LAVABO	ipág. 401
BIDÉ	ipág. 403
DUCHA	ipág. 406
BAÑO DUCHA	ipág. 424
BAÑERA	ipág. 427
ACCESORIOS DIVERSOS	ipág. 429

Información técnica

VENEZIA se suministra de serie SIN MANETA, a pedirse por separado.

Los monomandos lavabo se suministran con **limitadores de 5 l/min.**

- VERSIÓN CARTUCHO PROGRESIVO

Girando la maneta 90° en sentido antihorario se pasa del **agua fría > agua templada > agua caliente.**

AGUJEROS PARA INSTALACIÓN EN ENCIMERAS:

- Monomando de lavabo y bidé.



- Batería lavabo 3 elementos.

art. S704S

art. S705S

art. S804S

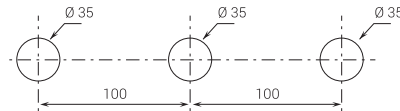

Mezcladores - pulsadores ON/OFF

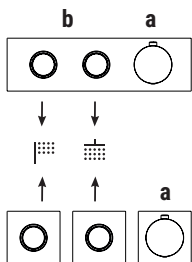

Los mezcladores termostáticos de ducha 3/4" con pulsadores ON/OFF y regulación del caudal están disponibles con placa "única", donde el termostático y los pulsadores están integrados (art. H572B+H572A), o bien con mezclador termostático y llaves de corte (con rosetas) que se pueden pedir por separado (art. H500B+H500A o art. H590B/H591B/H592B+H590A).

EJEMPLO:

art. H572B+H572A o art. H500B+H500A / H590B+H590A / H591B+H590A

a) control para regular la temperatura.

b) mando para: - función ON/OFF mediante presión del pulsador
- función de regulación del caudal mediante rotación del aro

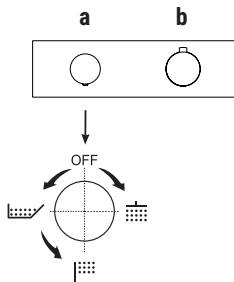

El monomando termostático ducha empotrado 3/4" está disponible:

- art. **G572B+D372A** - 2 salidas

- art. **G573B+D373A** - 3 salidas

EJEMPLO:

art. G573B+D373A

a) esviador giratorio con cierre - Desde la posición central, girando a la derecha se activa la 1° salida, al centro el cierre, girando a la izquierda se activa la 2° salida y luego la 3° salida en secuencia.

b) control para regular la temperatura.

Material básico: LATÓN

Acabados:

02 Cromo

95 Polished Nickel PVD

P5 Matt Gun Metal PVD





P6 Matt British Gold PVD

P9 Matt Copper PVD

S9 Golden Look PVD

* Para eventuales recambios, accesorios, artículos varios y prolongaciones, consultar las secciones específicas

Tipos y colores de los tiradores

	V748  CN	V748  CM	V748  CO	F948  CP	F948  CQ
02 Cromo	•	•	•	•	•
95 Polished Nickel PVD	•	•	•	•	•
P5 Matt Gun Metal PVD	•	•	•	•	•
P6 Matt British Gold PVD	•	•	•	•	•
P9 Matt Copper PVD	•	•	•	•	•
S9 Golden Look PVD	•	•	•	•	•

Manetas Venezia by Venini en cristal de Murano bicolor y filigrana

Estas manetas tienen una base de metal disponible en diversos acabados.

Magistralmente modeladas por la histórica vidriería Venini de Murano, las manetas Venezia bicolor y filigrana representan un producto nacido del encuentro entre diseño y el artesanal artístico italiano. La magia de la transparencia, la fluidez del color y el noble arte del cristal de Murano se funden y dan vida a pequeñas obras maestras de belleza y elegancia.

Cualquier matiz o burbuja que pueda aparecer en el vidrio son imperfecciones típicas presentes en la artesanía del vidrio. **Estos signos** son parte de la belleza y autenticidad de un producto de alta calidad hecho a mano en Italia y contribuyen a que cada pieza sea única e irrepetible.

Las manetas **VENEZIA by VENINI** se pueden instalar solo sobre sus cuerpos / códigos artículos Venezia by Venini incluidos en esta sección de la tarifa. Si se quisiese montar las manetas **Venezia** sobre los cuerpos Venezia by Venini, deberán comprar el kit de fijación específico (art. Z332 y art. Z333).

CARTUCHOS CERÁMICOS 1/4 DE GIRO

Batería lavabo 3 elementos

_longitud caño 17,5 cm



S704SW
SIN DESAGÜE

S704S
CON DESAGÜE

Batería lavabo alto 3 elementos

_longitud caño 17,5 cm



S705SW
SIN DESAGÜE

Batería lavabo a pared

_longitud caño 20 cm



S713SB+R010A
SIN DESAGÜE

Batería bidé 3 elementos

_longitud caño 12 cm



S709SW
SIN DESAGÜE

S709S
CON DESAGÜE

Batería bidé

_longitud caño 12 cm



S711SB+R011A
manetas a pared
CON DESAGÜE

HIDRO BIDÉ / HIDRO WC

Hidro bidé



E857B+M111A

Hidro WC



W291

V748CN

Maneta Venezia by Venini en cristal de Murano - BICOLOR AGUAMARINA VERDE

- soporte maneta en latón
- para artículos: S704SW - S704S - S705SW - S713SB - S709SW - S709S - S711SB - S765S - S767S - S991SB - S719SB - S717SB



Cromo	29 02 V748CN
Polished Nickel PVD	29 95 V748CN
Matt Gun Metal PVD	29 P5 V748CN
Matt British Gold PVD	29 P6 V748CN
Matt Copper PVD	29 P9 V748CN
Golden Look PVD	29 S9 V748CN

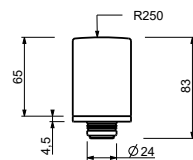

V748CM

Maneta Venezia by Venini en cristal de Murano - BICOLOR AMATISTA AMBAR

- soporte maneta en latón
- para artículos: S704SW - S704S - S705SW - S713SB - S709SW - S709S - S711SB - S765S - S767S - S991SB - S719SB - S717SB



Cromo	29 02 V748CM
Polished Nickel PVD	29 95 V748CM
Matt Gun Metal PVD	29 P5 V748CM
Matt British Gold PVD	29 P6 V748CM
Matt Copper PVD	29 P9 V748CM
Golden Look PVD	29 S9 V748CM

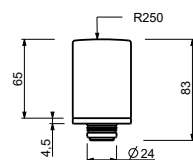

V748CO

Maneta Venezia by Venini en cristal de Murano - BICOLOR ROJO AMBAR

- soporte maneta en latón
- para artículos: S704SW - S704S - S705SW - S713SB - S709SW - S709S - S711SB - S765S - S767S - S991SB - S719SB - S717SB



Cromo	29 02 V748CO
Polished Nickel PVD	29 95 V748CO
Matt Gun Metal PVD	29 P5 V748CO
Matt British Gold PVD	29 P6 V748CO
Matt Copper PVD	29 P9 V748CO
Golden Look PVD	29 S9 V748CO

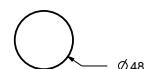
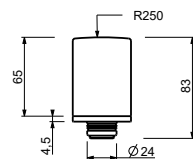

F948CP

Maneta Venezia by Venini en cristal de Murano - FILIGRANA BLANCA

- soporte maneta en latón
- para artículos: S704SW - S704S - S705SW - S713SB - S709SW - S709S - S711SB - S765S - S767S - S991SB - S719SB - S717SB



Cromo	29 02 F948CP
Polished Nickel PVD	29 95 F948CP
Matt Gun Metal PVD	29 P5 F948CP
Matt British Gold PVD	29 P6 F948CP
Matt Copper PVD	29 P9 F948CP
Golden Look PVD	29 S9 F948CP

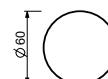
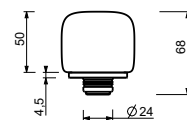

F948CQ**Maneta Venezia by Venini en cristal de Murano - FILIGRANA NEGRA**

- soporte maneta en latón
- para artículos: S704SW - S704S - S705SW - S713SB - S709SW - S709S - S711SB - S765S - S767S - S991SB - S719SB - S717SB

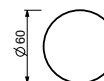
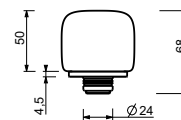

Cromo	29 02 F948CQ
Polished Nickel PVD	29 95 F948CQ
Matt Gun Metal PVD	29 P5 F948CQ
Matt British Gold PVD	29 P6 F948CQ
Matt Copper PVD	29 P9 F948CQ
Golden Look PVD	29 S9 F948CQ

S704SW

lead \emptyset free



Batería lavabo 3 elementos

- distancia a chorro 17,5 cm
- sin manetas
- limitador de caudal 5 l/m a 3 bar
- cartucho cerámico 90°
- flexos de alimentación
- SIN DESAGÜE

NOTA: manetas para pedir por separado, consultar la sección "Manetas"

Cromo	29 02 S704SW
Polished Nickel PVD	29 95 S704SW
Matt Gun Metal PVD	29 P5 S704SW
Matt British Gold PVD	29 P6 S704SW
Matt Copper PVD	29 P9 S704SW
Golden Look PVD	29 S9 S704SW

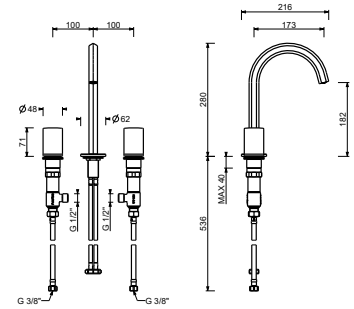

S704S

lead \emptyset free



Batería lavabo 3 elementos

- distancia a chorro 17,5 cm
- sin manetas
- limitador de caudal 5 l/m a 3 bar
- cartucho cerámico 90°
- flexos de alimentación
- CON DESAGÜE a presión

NOTA: manetas para pedir por separado, consultar la sección "Manetas"

Cromo	29 02 S704S
Polished Nickel PVD	29 95 S704S
Matt Gun Metal PVD	29 P5 S704S
Matt British Gold PVD	29 P6 S704S
Matt Copper PVD	29 P9 S704S
Golden Look PVD	29 S9 S704S

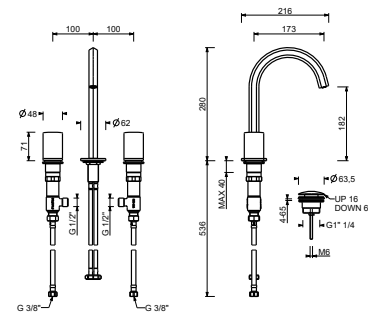

S705SW

lead \emptyset free



Batería lavabo alto 3 elementos

- distancia a chorro 17,5 cm
- sin manetas
- limitador de caudal 5 l/m a 3 bar
- cartucho cerámico 90°
- flexos de alimentación
- SIN DESAGÜE

NOTA: manetas para pedir por separado, consultar la sección "Manetas"

Cromo	29 02 S705SW
Polished Nickel PVD	29 95 S705SW
Matt Gun Metal PVD	29 P5 S705SW
Matt British Gold PVD	29 P6 S705SW
Matt Copper PVD	29 P9 S705SW
Golden Look PVD	29 S9 S705SW

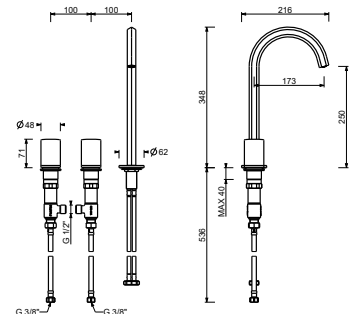

lead  free**Batería lavabo a pared**

- distancia a chorro 20 cm
- sin manetas
- limitador de caudal 5 l/m a 3 bar
- cartucho cerámico 90°
- entradas de 1/2"
- SIN DESAGÜE

NOTA: manetas para pedir por separado, consultar la sección "Manetas"

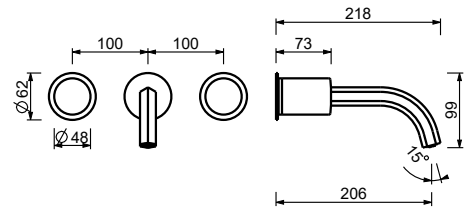
**S713SB****Parte externa**

Cromo	29 02 S713SB
Polished Nickel PVD	29 95 S713SB
Matt Gun Metal PVD	29 P5 S713SB
Matt British Gold PVD	29 P6 S713SB
Matt Copper PVD	29 P9 S713SB
Golden Look PVD	29 S9 S713SB

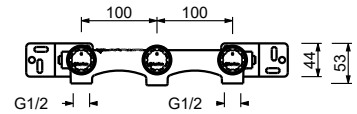
**R010A****Parte empotrable**

44 00 R010A

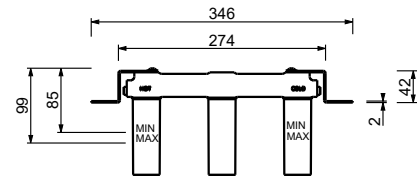

S709SW



Batería bidé 3 elementos

- distancia a chorro 12 cm
- sin manetas
- limitador de caudal 5 l/m a 3 bar
- cartucho cerámico 90°
- aireador orientable
- flexos de alimentación
- SIN DESAGÜE

NOTA: manetas para pedir por separado, consultar la sección "Manetas"

Cromo	29 02 S709SW
Polished Nickel PVD	29 95 S709SW
Matt Gun Metal PVD	29 P5 S709SW
Matt British Gold PVD	29 P6 S709SW
Matt Copper PVD	29 P9 S709SW
Golden Look PVD	29 S9 S709SW

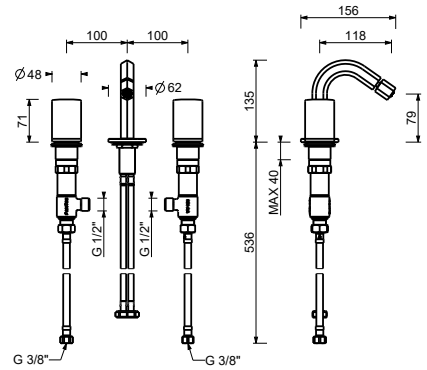

S709S



Batería bidé 3 elementos

- distancia a chorro 12 cm
- sin manetas
- limitador de caudal 5 l/m a 3 bar
- cartucho cerámico 90°
- aireador orientable
- flexos de alimentación
- CON DESAGÜE a presión

NOTA: manetas para pedir por separado, consultar la sección "Manetas"

Cromo	29 02 S709S
Polished Nickel PVD	29 95 S709S
Matt Gun Metal PVD	29 P5 S709S
Matt British Gold PVD	29 P6 S709S
Matt Copper PVD	29 P9 S709S
Golden Look PVD	29 S9 S709S

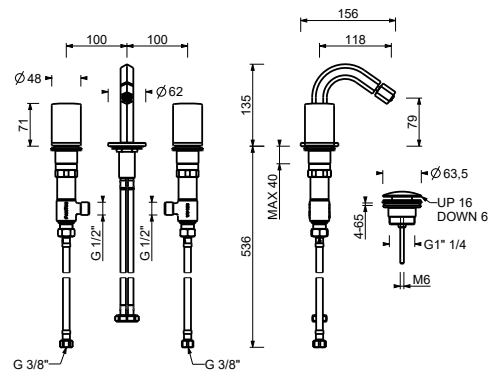

Monobloc bidé

- distancia a chorro 12 cm
- sin manetas
- manetas a pared
- limitador de caudal 5 l/m a 3 bar
- cartucho cerámico 90°
- aireador orientable
- flexos de alimentación
- CON DESAGÜE a presión

NOTA: manetas para pedir por separado, consultar la sección "Manetas"

S711SB



Parte externa

Cromo	29 02 S711SB
Polished Nickel PVD	29 95 S711SB
Matt Gun Metal PVD	29 P5 S711SB
Matt British Gold PVD	29 P6 S711SB
Matt Copper PVD	29 P9 S711SB
Golden Look PVD	29 S9 S711SB

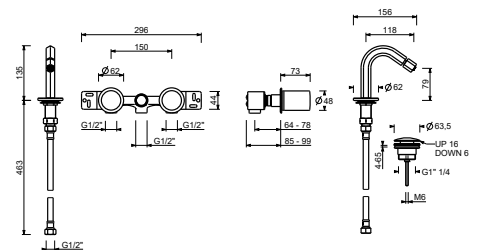

R011A



Parte empotrable

44 00 R011A

Hidro bidé

- para higiene personal
- Mezclador de ducha incluido
- toma de agua y soporte teleducha
- con embellecedores
- flexos en latón 120 cm
- entrada de 1/2"

N.B. listado completo de los acabados en la sección accesorios diversos al final de la tarifa

E857B



Parte externa

Cromo	50 02 E857B
Polished Nickel PVD	50 95 E857B
Matt Gun Metal PVD	50 P5 E857B
Matt British Gold PVD	50 P6 E857B
Matt Copper PVD	50 P9 E857B
Golden Look PVD	50 S9 E857B

M111A

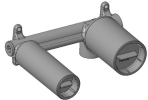

Parte empotrable

44 00 M111A

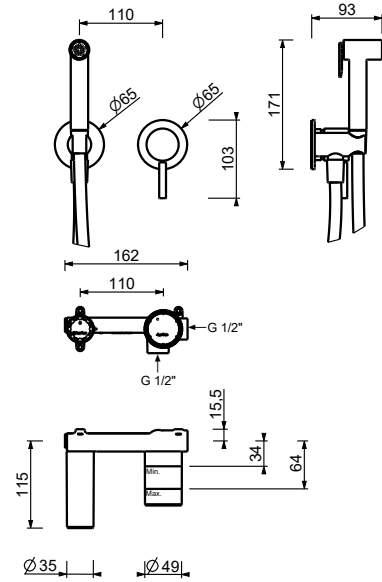

W291

Hidro WC

- para limpieza WC
- toma de agua y soporte teleducha
- llave de cierre
- embellecedor redondo
- flexos en latón 120 cm

N.B. listado completo de los acabados en la sección accesorios diversos al final de la tarifa



Cromo	91 02 W291
Polished Nickel PVD	91 95 W291
Matt Gun Metal PVD	91 P5 W291
Matt British Gold PVD	91 P6 W291
Matt Copper PVD	91 P9 W291
Golden Look PVD	91 S9 W291

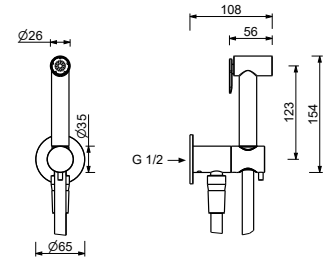

CARTUCHO TERMOSTÁTICO

Monomando ducha empotrado

_entradas de 1/2"



G423B+M523A

2 salidas



G423B+M623A

2 salidas

Monomando ducha empotrado

_entradas de 3/4"



H572B+H572A

2 salidas

botones ON/OFF
con ajuste de caudal

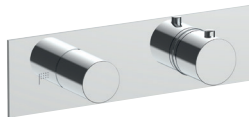

G572B+D372A

2 salidas

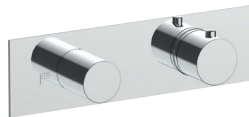

G573B+D373A

3 salidas



H700B+H500A



H790B+H590A

llave de paso

botón ON/OFF
con regulación de caudal
serigrafía rociador



H791B+H590A

llave de paso

botón ON/OFF
con regulación de caudal
serigrafía de la ducha de mano



H792B+H590A

llave de paso

botón ON/OFF
con regulación de caudal
serigrafía AUX



S991SB+D491A

llave de paso

Monomando termostático ducha empotrado 1/2"

- manetas
- con embellecedores
- desviador giratorio **2 salidas**
- entradas de 1/2"
- aislamiento acústico
- solo para montaje vertical

G423B



Parte externa

Cromo	87 02 G423B
Polished Nickel PVD	87 95 G423B
Matt Gun Metal PVD	87 P5 G423B
Matt British Gold PVD	87 P6 G423B
Matt Copper PVD	87 P9 G423B
Golden Look PVD	87 S9 G423B

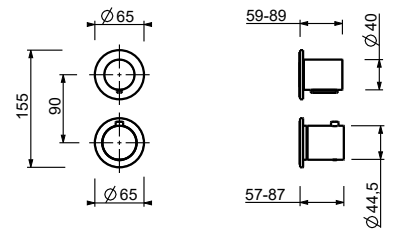

M523A



Parte empotrable

44 00 M523A

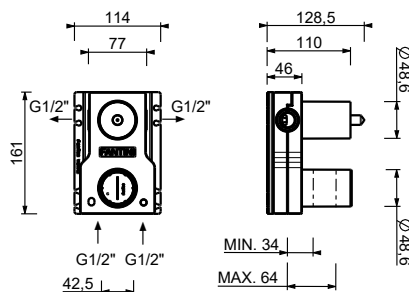

Monomando termostático ducha empotrado 1/2"

- manetas
- con embellecedores
- desviador giratorio **2 salidas**
- entradas de 1/2"
- aislamiento acústico
- solo para montaje horizontal

G423B



Parte externa

Cromo	87 02 G423B
Polished Nickel PVD	87 95 G423B
Matt Gun Metal PVD	87 P5 G423B
Matt British Gold PVD	87 P6 G423B
Matt Copper PVD	87 P9 G423B
Golden Look PVD	87 S9 G423B

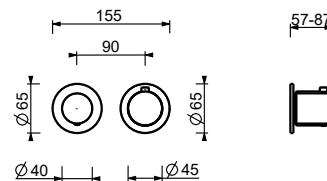

M623A

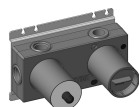

Parte empotrable

44 00 M623A

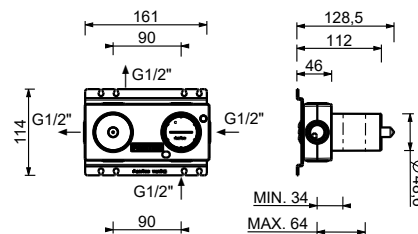

Monomando termostático ducha empotrado 3/4"

- maneta
- botones ON/OFF con ajuste de caudal
- aislamiento acústico
- solo para montaje horizontal
- entradas de 3/4"
- **2 salidas** de 1/2"

H572B

Parte externa

Cromo	87 02 H572B
Polished Nickel PVD	87 95 H572B
Matt Gun Metal PVD	87 P5 H572B
Matt British Gold PVD	87 P6 H572B
Matt Copper PVD	87 P9 H572B
Golden Look PVD	87 S9 H572B

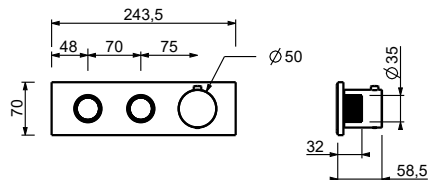

H572A

Parte empotrable

44 00 H572A

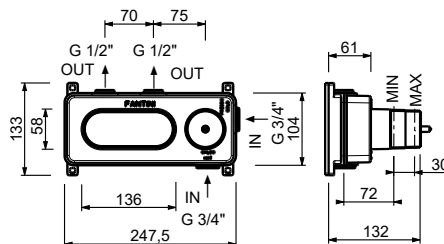
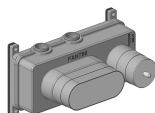

Monomando termostático ducha empotrado 3/4"

- manetas
- desviador giratorio con cierre **2 salidas**
- solo para montaje horizontal
- entradas de 3/4"

G572B

Parte externa

Cromo	87 02 G572B
Polished Nickel PVD	87 95 G572B
Matt Gun Metal PVD	87 P5 G572B
Matt British Gold PVD	87 P6 G572B
Matt Copper PVD	87 P9 G572B
Golden Look PVD	87 S9 G572B

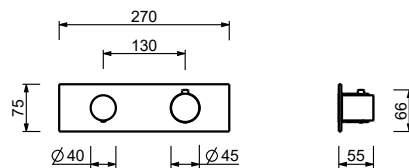
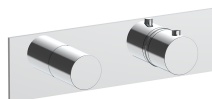

D372A

Parte empotrable

19 00 D372A

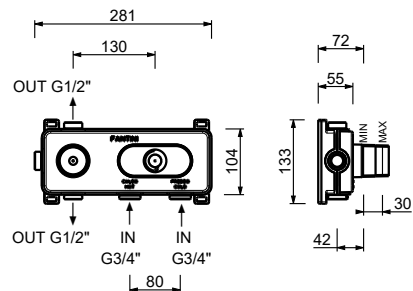

Monomando termostático ducha empotrado 3/4"

- manetas
- desviador giratorio con cierre **3 salidas**
- solo para montaje horizontal
- entradas de 3/4"

G573B

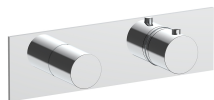

Parte externa

Cromo	87 02 G573B
Polished Nickel PVD	87 95 G573B
Matt Gun Metal PVD	87 P5 G573B
Matt British Gold PVD	87 P6 G573B
Matt Copper PVD	87 P9 G573B
Golden Look PVD	87 S9 G573B

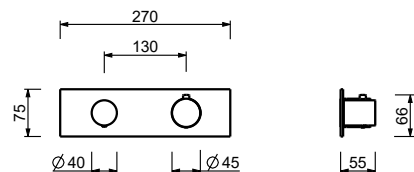

D373A



Parte empotrable

19 00 D373A

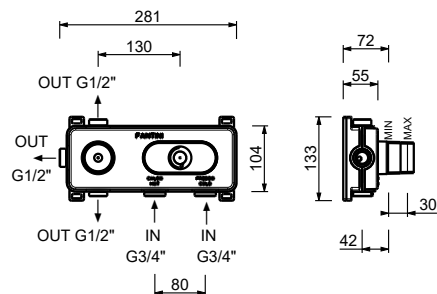

Monomando termostático ducha empotrado 3/4"

- maneta
- entradas de 1/2"
- aislamiento acústico
- sin llave de cierre, **debe pedirse por separado**

NOTA: El mezclador debe pedirse siempre con una válvula de cierre de 3/4" o 1/2"

H700B



Parte externa

Cromo	87 02 H700B
Polished Nickel PVD	87 95 H700B
Matt Gun Metal PVD	87 P5 H700B
Matt British Gold PVD	87 P6 H700B
Matt Copper PVD	87 P9 H700B
Golden Look PVD	87 S9 H700B

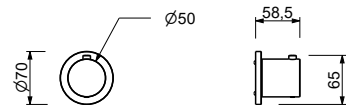

H500A



Parte empotrable

44 00 H500A

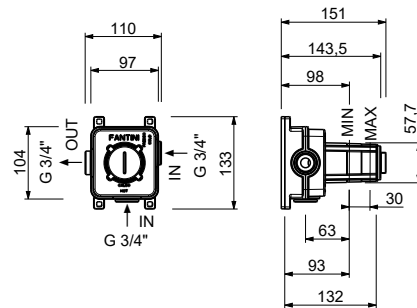

Llave de paso

- botón ON/OFF con regulación de caudal **serigrafía rociador**
- aislamiento acústico
- Para instalación horizontal y vertical
- entradas de 1/2"

H790B



Parte externa

Cromo	87 02 H790B
Polished Nickel PVD	87 95 H790B
Matt Gun Metal PVD	87 P5 H790B
Matt British Gold PVD	87 P6 H790B
Matt Copper PVD	87 P9 H790B
Golden Look PVD	87 S9 H790B

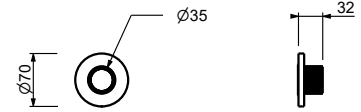

H590A



Parte empotrable

44 00 H590A

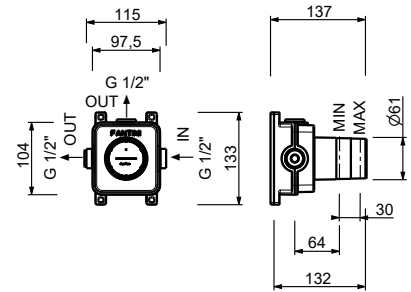

Llave de paso

- botón ON/OFF con regulación de caudal **serigrafía de la ducha de mano**
- aislamiento acústico
- Para instalación horizontal y vertical
- entradas de 1/2"

H791B



Parte externa

Cromo	87 02 H791B
Polished Nickel PVD	87 95 H791B
Matt Gun Metal PVD	87 P5 H791B
Matt British Gold PVD	87 P6 H791B
Matt Copper PVD	87 P9 H791B
Golden Look PVD	87 S9 H791B

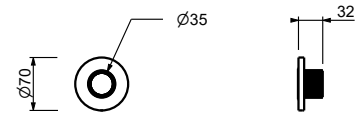

H590A



Parte empotrable

44 00 H590A

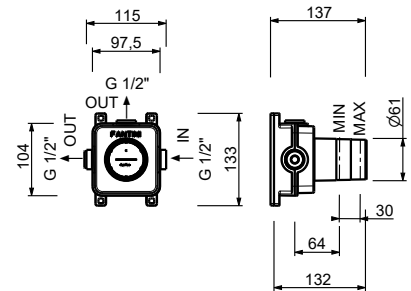

Llave de paso

- botón ON/OFF con regulación de caudal **serigrafía AUX**
- aislamiento acústico
- Para instalación horizontal y vertical
- entradas de 1/2"

H792B



Parte externa

Cromo	87 02 H792B
Polished Nickel PVD	87 95 H792B
Matt Gun Metal PVD	87 P5 H792B
Matt British Gold PVD	87 P6 H792B
Matt Copper PVD	87 P9 H792B
Golden Look PVD	87 S9 H792B

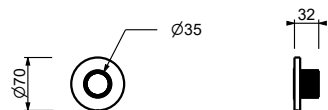

H590A



Parte empotrable

44 00 H590A

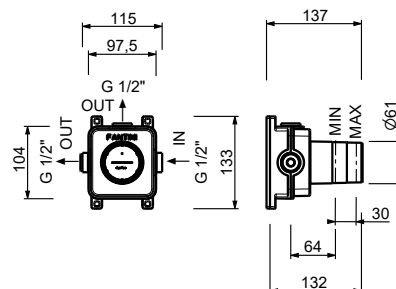

Llave de paso 3/4"

- sin maneta
- cartucho cerámico 90°
- entradas de 3/4"

NOTA: maneta para pedir por separado, consultar la sección "Manetas"

S991SB



Parte externa

Cromo	29 02 S991SB
Polished Nickel PVD	29 95 S991SB
Matt Gun Metal PVD	29 P5 S991SB
Matt British Gold PVD	29 P6 S991SB
Matt Copper PVD	29 P9 S991SB
Golden Look PVD	29 S9 S991SB



D491A



Parte empotrable

19 00 D491A

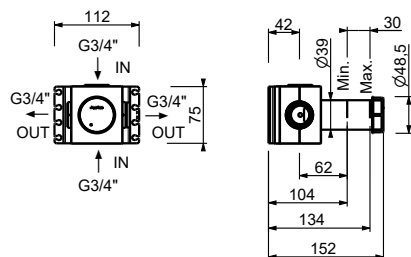

W269

Opcional - Sistema Easy Fix

placa y conexiones

• para instalación facilitada horizontal o vertical termostáticos

- para instalación art. H500A / H590A - **1 salida**
- para instalación art. H500A / H590A - **2 salidas**

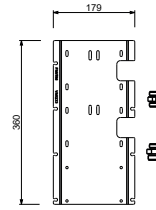
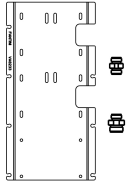

EJEMPLO COMBINACIONES - 1 SALIDA



EJEMPLO COMBINACIONES - 2 SALIDAS



91 00 W269

W270

Opcional - Sistema Easy Fix

placa y conexiones

• para instalación facilitada horizontal o vertical termostáticos

- para instalación tres salidas para instalación art. H500A / H590A - **3 salidas**

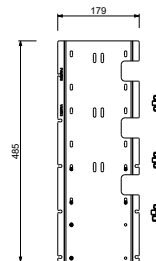
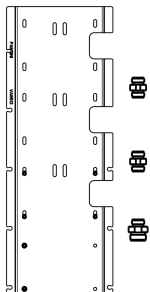

EJEMPLO COMBINACIONES - 3 SALIDAS



91 00 W270

W275

Opcional - Sistema Easy Fix

placa y conexiones

• para instalación facilitada horizontal o vertical termostáticos

- para instalación art. H500A / D491A - **1 salida**
- para instalación art. H500A / D491A - **2 salidas**

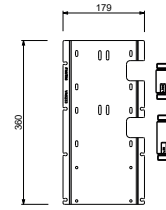
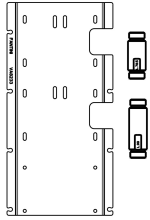

EJEMPLO COMBINACIONES - 1 SALIDA

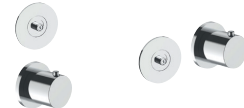

EJEMPLO COMBINACIONES - 2 SALIDAS



91 00 W275

W276

Opcional - Sistema Easy Fix

placa y conexiones

• para instalación facilitada horizontal o vertical termostáticos

- para instalación tres salidas para instalación art. H500A / D491A - **3 salidas**

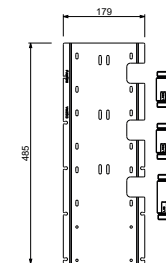
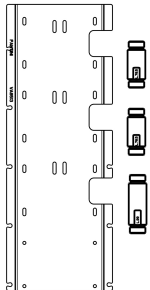

EJEMPLO COMBINACIONES - 3 SALIDAS

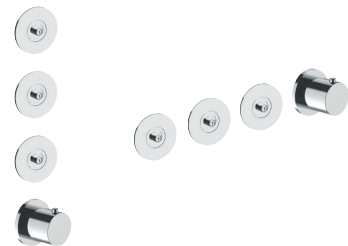

91 00 W276

8083

Rociador Iluvia

- Ø 24 cm
- material básico: acero
- limitador de caudal 12 l/m a 3 bar
- sistema anticalcáreo
- entrada de 1/2"
- válvula anti-retorno

**NOTA: Condiciones necesarias para el correcto funcionamiento:
Caudal mín.: 10 l/min**

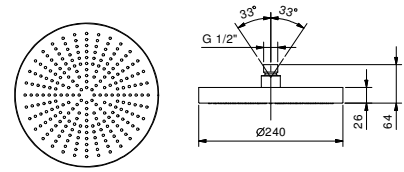

Cromo	86 02 8083
Polished Nickel PVD	86 95 8083
Matt Gun Metal PVD	86 P5 8083
Matt British Gold PVD	86 P6 8083
Matt Copper PVD	86 P9 8083
Golden Look PVD	86 S9 8083

8157

Rociador Iluvia

- Ø 25 cm
- material básico: ABS
- limitador de caudal 9 l/m a 3 bar
- sistema anticalcáreo
- entrada de 1/2"
- válvula anti-retorno

**NOTA: Condiciones necesarias para el correcto funcionamiento:
Caudal mín.: 10 l/min**

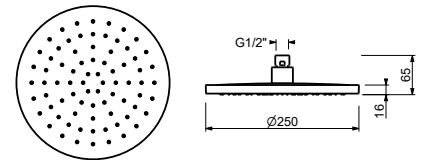

Cromo	86 02 8157
-------	------------

8159

Rociador Iluvia

- Ø 25 cm
- material básico: latón
- limitador de caudal 9 l/m a 3 bar
- sistema anticalcáreo
- entrada de 1/2"
- válvula anti-retorno

**NOTA: Condiciones necesarias para el correcto funcionamiento:
Caudal mín.: 10 l/min**

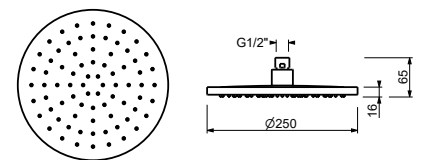

Cromo	86 02 8159
Polished Nickel PVD	86 95 8159
Matt Gun Metal PVD	86 P5 8159
Matt British Gold PVD	86 P6 8159
Matt Copper PVD	86 P9 8159
Golden Look PVD	86 S9 8159

K073

Rociador lluvia

- ACQUAFIT
- Funciones agua**
- función 1: 240 chorros anticalcareos lluvia enfocada en el centro
- Ø 30 cm
- material básico: acero
- válvula anti-retorno
- limitador de caudal 14 l/m a 3 bar
- sistema anticalcáreo
- entrada de 1/2"

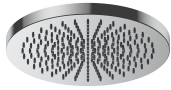

**NOTA: condiciones necesarias para el correcto funcionamiento:
Caudal mín.: 12 l/min**

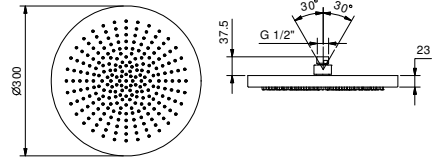

Acero Brillante	79 38 K073
Polished Nickel PVD	79 95 K073
Matt Gun Metal PVD	79 P5 K073
Matt British Gold PVD	79 P6 K073
Matt Copper PVD	79 P9 K073
Golden Look PVD	79 S9 K073

8084

Rociador lluvia

- Ø 36 cm
- material básico: acero
- sistema anticalcáreo
- entrada de 1/2"
- válvula anti-retorno

NOTA: Condiciones necesarias para el correcto funcionamiento:
Caudal mín.: 15 l/m

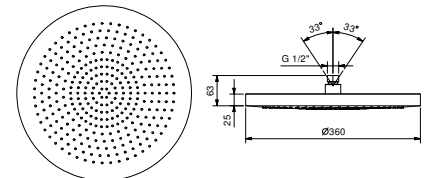

Cromo	86 02 8084
-------	------------

Rociador doble

- lluvia
- cascada
- material básico: latón
- para instalación a pared
- limitador de caudal 17 l/m a 3 bar
- sistema anticalcáreo
- entrada de 1/2"
- caudal mínimo 12 l/min

**NOTA: condiciones necesarias para el correcto funcionamiento:
Caudal mín.: 12 l/min**

8035B

Parte externa

Cromo	86 02 8035B
Polished Nickel PVD	86 95 8035B
Matt Gun Metal PVD	86 P5 8035B
Matt British Gold PVD	86 P6 8035B
Matt Copper PVD	86 P9 8035B
Golden Look PVD	86 S9 8035B

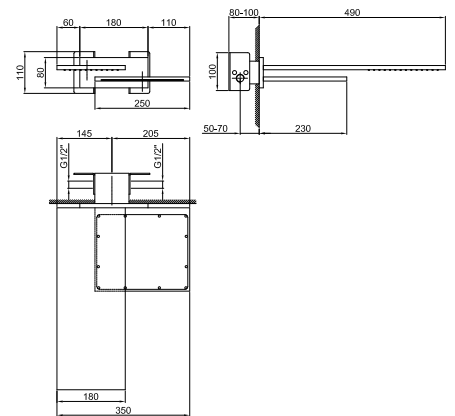
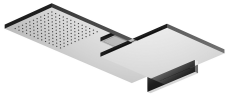

8035A

Parte empotrable

86 00 8035A



Rociador lluvia

- material básico: latón
- para instalación a pared
- limitador de caudal 17 l/m a 3 bar
- sistema anticalcáreo
- entrada de 1/2"
- caudal mínimo 10 l/min

**NOTA: Condiciones necesarias para el correcto funcionamiento:
Caudal mín.: 10 l/min**

8036B

Parte externa

Cromo	86 02 8036B
Polished Nickel PVD	86 95 8036B
Matt Gun Metal PVD	86 P5 8036B
Matt British Gold PVD	86 P6 8036B
Matt Copper PVD	86 P9 8036B
Golden Look PVD	86 S9 8036B

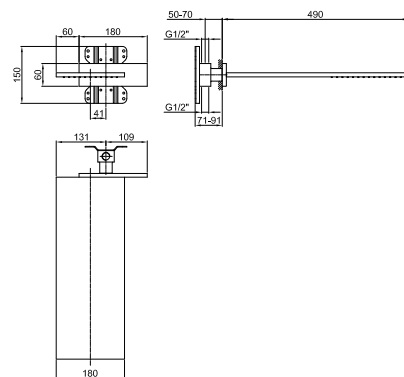
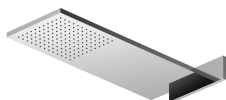

8036A

Parte empotrable

86 00 8036A



8027

Brazo ducha

- longitud 30 cm
- embellecedor redondo
- para instalación a pared
- entrada de 1/2"

Cromo	86 02 8027
Polished Nickel PVD	86 95 8027
Matt Gun Metal PVD	86 P5 8027
Matt British Gold PVD	86 P6 8027
Matt Copper PVD	86 P9 8027
Golden Look PVD	86 S9 8027

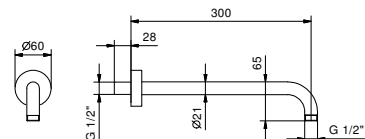

OPCIONAL: Parte empotrable para cartón-yeso

W046

91 00 W046

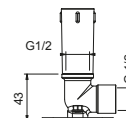

8137

Brazo ducha

- longitud 35 cm
- embellecedor redondo
- para instalación a pared
- entrada de 1/2"



Cromo	86 02 8137
Polished Nickel PVD	86 95 8137
Matt Gun Metal PVD	86 P5 8137
Matt British Gold PVD	86 P6 8137
Matt Copper PVD	86 P9 8137
Golden Look PVD	86 S9 8137

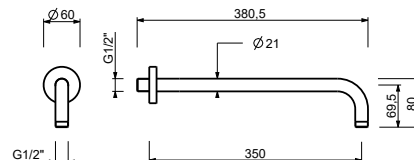

OPCIONAL: Parte empotrable para cartón-yeso

W046 91 00 W046

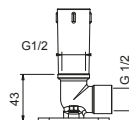

8124

Brazo ducha

- longitud 40 cm
- embellecedor redondo
- para instalación a pared
- entrada de 1/2"



Cromo	86 02 8124
Polished Nickel PVD	86 95 8124
Matt Gun Metal PVD	86 P5 8124
Matt British Gold PVD	86 P6 8124
Matt Copper PVD	86 P9 8124
Golden Look PVD	86 S9 8124

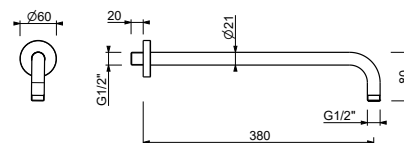

OPCIONAL: Parte empotrable para cartón-yeso

W046 91 00 W046

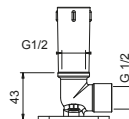

8028

Brazo ducha

- longitud 45 cm
- embellecedor redondo
- para instalación a pared
- entrada de 1/2"



Cromo	86 02 8028
Polished Nickel PVD	86 95 8028
Matt Gun Metal PVD	86 P5 8028
Matt British Gold PVD	86 P6 8028
Matt Copper PVD	86 P9 8028
Golden Look PVD	86 S9 8028

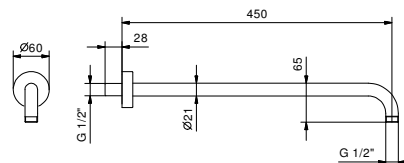

OPCIONAL: Parte empotrable para cartón-yeso

W046 91 00 W046

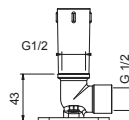

9231

Brazo ducha

- longitud 30 cm
- embellecedor redondo
- para instalación a pared
- entrada de 1/2"



Cromo	86 02 9231
Polished Nickel PVD	86 95 9231
Matt Gun Metal PVD	86 P5 9231
Matt British Gold PVD	86 P6 9231
Matt Copper PVD	86 P9 9231
Golden Look PVD	86 S9 9231

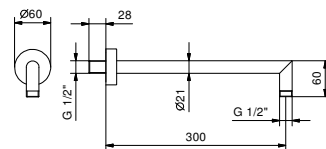

OPCIONAL: Parte empotrable para cartón-yeso

W046 91 00 W046

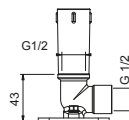

8011

Brazo ducha

- longitud 45 cm
- embellecedor redondo
- para instalación a pared
- entrada de 1/2"



Cromo	86 02 8011
Polished Nickel PVD	86 95 8011
Matt Gun Metal PVD	86 P5 8011
Matt British Gold PVD	86 P6 8011
Matt Copper PVD	86 P9 8011
Golden Look PVD	86 S9 8011

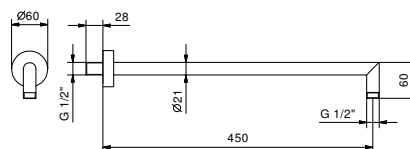

OPCIONAL: Parte empotrable para cartón-yeso

W046 91 00 W046

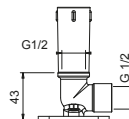

8121

Brazo ducha

- longitud 10 cm
- embellecedor redondo
- para instalación a techo
- entrada de 1/2"



Cromo	86 02 8121
Polished Nickel PVD	86 95 8121
Matt Gun Metal PVD	86 P5 8121
Matt British Gold PVD	86 P6 8121
Matt Copper PVD	86 P9 8121
Golden Look PVD	86 S9 8121

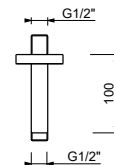

OPCIONAL: Parte empotrable para cartón-yeso

W046 91 00 W046

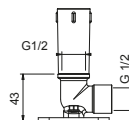

9236

Brazo ducha

- longitud 25 cm
- embellecedor redondo
- para instalación a techo
- entrada de 1/2"



Cromo	86 02 9236
Polished Nickel PVD	86 95 9236
Matt Gun Metal PVD	86 P5 9236
Matt British Gold PVD	86 P6 9236
Matt Copper PVD	86 P9 9236
Golden Look PVD	86 S9 9236

OPCIONAL: Parte empotrable para cartón-yeso

W046 91 00 W046

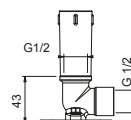
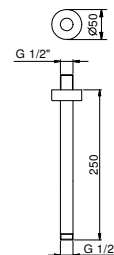

9237

Brazo ducha

- longitud 45 cm
- embellecedor redondo
- para instalación a techo
- entrada de 1/2"



Cromo	86 02 9237
Polished Nickel PVD	86 95 9237
Matt Gun Metal PVD	86 P5 9237
Matt British Gold PVD	86 P6 9237
Matt Copper PVD	86 P9 9237
Golden Look PVD	86 S9 9237

OPCIONAL: Parte empotrable para cartón-yeso

W046 91 00 W046

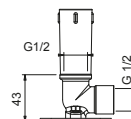
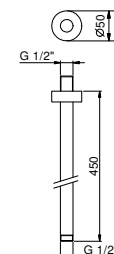

8158

Conjunto de ducha

- embellecedor redondo Ø 70 mm grosor 7,5
- teleducha FIT
- toma de agua y soporte teleducha
- flexo PVC 150 cm
- entrada de 1/2"



Cromo	86 02 8158
Polished Nickel PVD	86 95 8158
Matt Gun Metal PVD	86 P5 8158
Matt British Gold PVD	86 P6 8158
Matt Copper PVD	86 P9 8158
Golden Look PVD	86 S9 8158

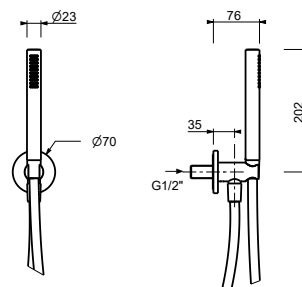

5943

Conjunto de ducha

- embellecedor redondo Ø 65 mm grosor 4
- teleducha VENEZIA
- toma de agua y soporte teleducha
- flexo en latón 150 cm
- flexo en latón 140 cm en versiones PVD
- entrada de 1/2"



Cromo	29 02 5943
Polished Nickel PVD	29 95 5943
Matt Gun Metal PVD	29 P5 5943
Matt British Gold PVD	29 P6 5943
Matt Copper PVD	29 P9 5943
Golden Look PVD	29 S9 5943

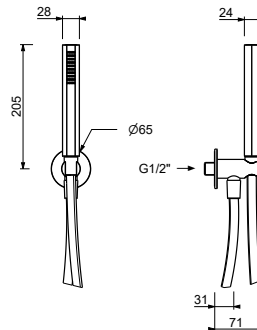

5944

Conjunto de ducha

- embellecedor redondo Ø 65 mm grosor 4
- teleducha FIT
- toma de agua y soporte teleducha
- flexo en latón 150 cm
- flexo en latón 140 cm en versiones PVD
- entrada de 1/2"



Cromo	29 02 5944
Polished Nickel PVD	29 95 5944
Matt Gun Metal PVD	29 P5 5944
Matt British Gold PVD	29 P6 5944
Matt Copper PVD	29 P9 5944
Golden Look PVD	29 S9 5944

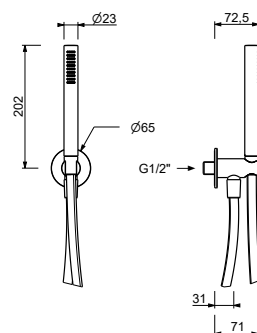

9849

Teleducha

- VENEZIA
- limitador de caudal 9 l/min
- sistema anticalcáreo
- válvula anti-retorno



Cromo	90 02 9849
Polished Nickel PVD	90 95 9849
Matt Gun Metal PVD	90 P5 9849
Matt British Gold PVD	90 P6 9849
Matt Copper PVD	90 P9 9849
Golden Look PVD	90 S9 9849

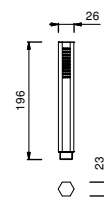

8783

Teleducha

- FIT
- material básico: latón
- limitador de caudal 9 l/min
- sistema anticalcáreo
- válvula anti-retorno



Cromo	90 02 8783
Polished Nickel PVD	90 95 8783
Matt Gun Metal PVD	90 P5 8783
Matt British Gold PVD	90 P6 8783
Matt Copper PVD	90 P9 8783
Golden Look PVD	90 S9 8783

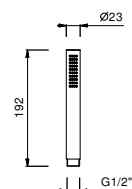

9248

Jet lateral

- material básico: latón
- articulado
- sistema anticalcáreo
- entrada de 1/2"

**NOTA: condiciones necesarias para el correcto funcionamiento:
Caudal mín.: 12 l/min**

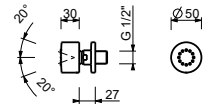

Cromo	86 02 9248
Polished Nickel PVD	86 95 9248
Matt Gun Metal PVD	86 P5 9248
Matt British Gold PVD	86 P6 9248
Matt Copper PVD	86 P9 9248
Golden Look PVD	86 S9 9248

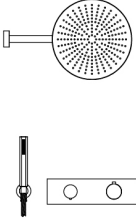
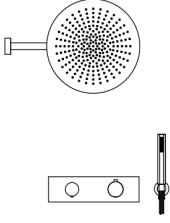
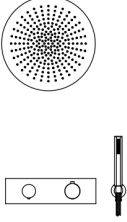
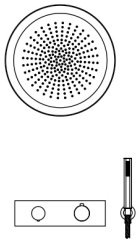
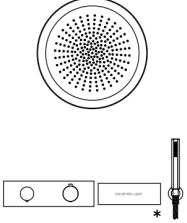
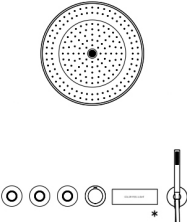
COMPOSICIÓN.1	Art.	Descripción	Acabados
	8027 8083 G572B+D372A	Brazo ducha Rociador lluvia Monomando termostático ducha empotrado 3/4"	02 Cromo 95 Polished Nickel PVD P5 Matt Gun Metal PVD P6 Matt British Gold PVD
	5943	Conjunto de ducha	P9 Matt Copper PVD S9 Golden Look PVD
COMPOSICIÓN.2	Art.	Descripción	Acabados
	8027 K073 G572B+D372A	Brazo ducha Rociador lluvia Monomando termostático ducha empotrado 3/4"	02 Cromo 95 Polished Nickel PVD P5 Matt Gun Metal PVD P6 Matt British Gold PVD
	5943	Conjunto de ducha	P9 Matt Copper PVD S9 Golden Look PVD
COMPOSICIÓN.3	Art.	Descripción	Acabados
	K072 G572B+D372A	Rociador lluvia Monomando termostático ducha empotrado 3/4"	02 Cromo 95 Polished Nickel PVD P5 Matt Gun Metal PVD P6 Matt British Gold PVD
	5943	Conjunto de ducha	P9 Matt Copper PVD S9 Golden Look PVD
COMPOSICIÓN.4	Art.	Descripción	Acabados
	K062 G572B+D372A	Rociador lluvia Monomando termostático ducha empotrado 3/4"	02 Cromo 95 Polished Nickel PVD P5 Matt Gun Metal PVD P6 Matt British Gold PVD
	5943	Conjunto de ducha	P9 Matt Copper PVD S9 Golden Look PVD
COMPOSICIÓN.5	Art.	Descripción	Acabados
	K061 G572B+D372A	Rociador multifunción Dream Monomando termostático ducha empotrado 3/4"	02 Cromo 95 Polished Nickel PVD P5 Matt Gun Metal PVD P6 Matt British Gold PVD
	K101 OPT. 5943	Pulsadores de control touch Conjunto de ducha	P9 Matt Copper PVD S9 Golden Look PVD
			*opcional K101 Pulsadores de control touch
COMPOSICIÓN.6	Art.	Descripción	Acabados
	V561 H700B+H500A	Rociador multifunción Dream Monomando termostático ducha empotrado 3/4"	02 Cromo 95 Polished Nickel PVD P5 Matt Gun Metal PVD P6 Matt British Gold PVD
	H790B+H590A H791B+H590A H792B+H590A K101 OPT. 8158	Llave de paso Llave de paso Llave de paso Pulsadores de control touch Conjunto de ducha	P9 Matt Copper PVD S9 Golden Look PVD
			*opcional K101 Pulsadores de control touch

CARTUCHOS CERÁMICOS 1/4 DE GIRO

Monomando baño/ducha empotrado

_entradas de 1/2"
_longitud caño 20 cm



S719SB+N019A
2 salidas

Monomando baño/ducha empotrado

_entradas de 1/2"



S717SB+N017A
2 salidas

Grupo bañera repisa

_entradas de 3/4"
_longitud caño 17,5 cm



S765S
2 salidas

Grupo bañera repisa

_entradas de 3/4"



S767S
2 salidas

Monomando baño/ducha a suelo

_entradas de 1/2"
_longitud caño 25 cm



N080B+R080A
2 salidas

Caño bañera empotrado

_longitud caño 14,5 cm



5041B+5041A



5042B+5041A

Caño bañera a pared

_longitud caño 20 cm



8315

Caño bañera a suelo

_longitud caño 24 cm



8418

Batería baño/ducha empotrada

- distancia a chorro 20 cm
- sin manetas
- desviador giratorio **2 salidas**
- teleducha VENEZIA
- toma de agua y soporte teleducha
- flexo en latón 150 cm
- flexo en latón 140 cm en versiones PVD
- cartucho cerámico 90°
- entradas de 1/2"

NOTA: manetas para pedir por separado, consultar la sección "Manetas"

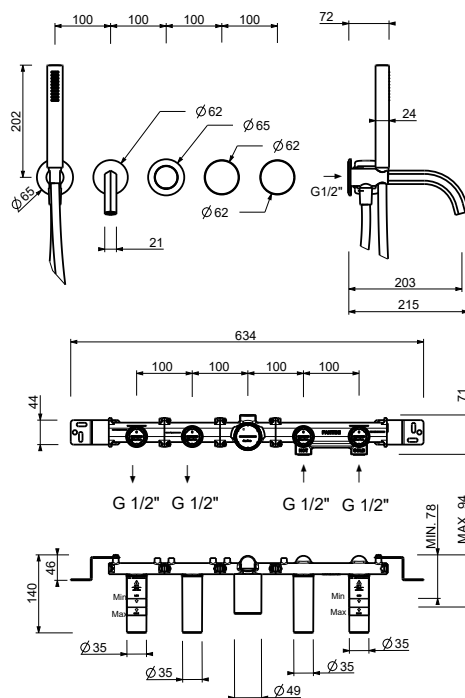

S719SB



N019A



Parte externa

Cromo	29 02 S719SB
Polished Nickel PVD	29 95 S719SB
Matt Gun Metal PVD	29 P5 S719SB
Matt British Gold PVD	29 P6 S719SB
Matt Copper PVD	29 P9 S719SB
Golden Look PVD	29 S9 S719SB

Parte empotrable

44 00 N019A

Batería baño/ducha empotrada

- sin manetas
- sin caño
- desviador giratorio **2 salidas**
- teleducha VENEZIA
- toma de agua y soporte teleducha
- flexo en latón 150 cm
- flexo en latón 140 cm en versiones PVD
- cartucho cerámico 90°
- entradas de 1/2"

NOTA: manetas para pedir por separado, consultar la sección "Manetas"

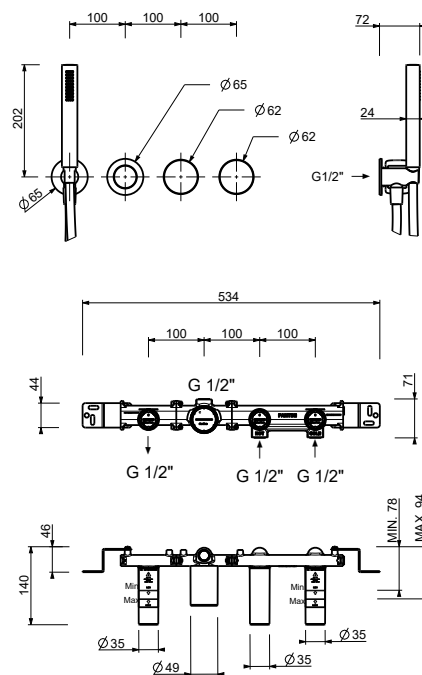

S717SB



N017A



Parte externa

Cromo	29 02 S717SB
Polished Nickel PVD	29 95 S717SB
Matt Gun Metal PVD	29 P5 S717SB
Matt British Gold PVD	29 P6 S717SB
Matt Copper PVD	29 P9 S717SB
Golden Look PVD	29 S9 S717SB

Parte empotrable

44 00 N017A

S765S

Grupo bañera repisa

- distancia a chorro 17,5 cm
- sin manetas
- 5 agujeros
- desviador con pulsador **2 salidas**
- teleducha VENEZIA
- flexo 150 cm
- cartucho cerámico 90°
- entradas de 3/4"
- flexos de alimentación



NOTA: manetas para pedir por separado, consultar la sección "Manetas"

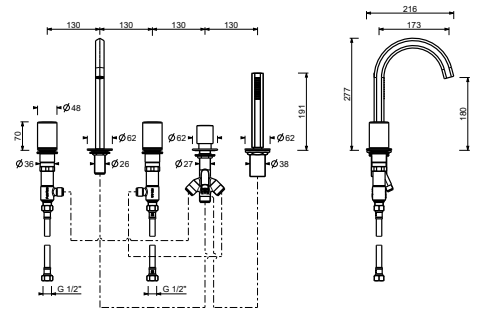

Cromo	29 02 S765S
Polished Nickel PVD	29 95 S765S
Matt Gun Metal PVD	29 P5 S765S
Matt British Gold PVD	29 P6 S765S
Matt Copper PVD	29 P9 S765S
Golden Look PVD	29 S9 S765S

S767S

Grupo bañera repisa

- sin manetas
- sin caño
- 4 agujeros
- desviador con pulsador **2 salidas**
- teleducha VENEZIA
- flexo 150 cm
- cartucho cerámico 90°
- entradas de 3/4"
- flexos de alimentación



NOTA: manetas para pedir por separado, consultar la sección "Manetas"

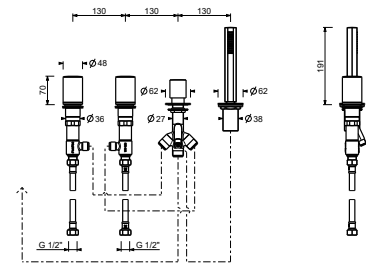

Cromo	29 02 S767S
Polished Nickel PVD	29 95 S767S
Matt Gun Metal PVD	29 P5 S767S
Matt British Gold PVD	29 P6 S767S
Matt Copper PVD	29 P9 S767S
Golden Look PVD	29 S9 S767S

Monomando baño/ducha a suelo

- distancia a chorro 25 cm
- maneta
- maneta apertura/cierre con regulación de caudal y temperatura ducha
- teleducha VENEZIA
- soporte teleducha
- flexo PVC 150 cm
- entradas de 1/2"
- sobre columna

N080B



R080A



Parte externa

Cromo	29 02 N080B
Polished Nickel PVD	29 95 N080B
Matt Gun Metal PVD	29 P5 N080B
Matt British Gold PVD	29 P6 N080B
Matt Copper PVD	29 P9 N080B
Golden Look PVD	29 S9 N080B

Parte empotrable

44 00 R080A

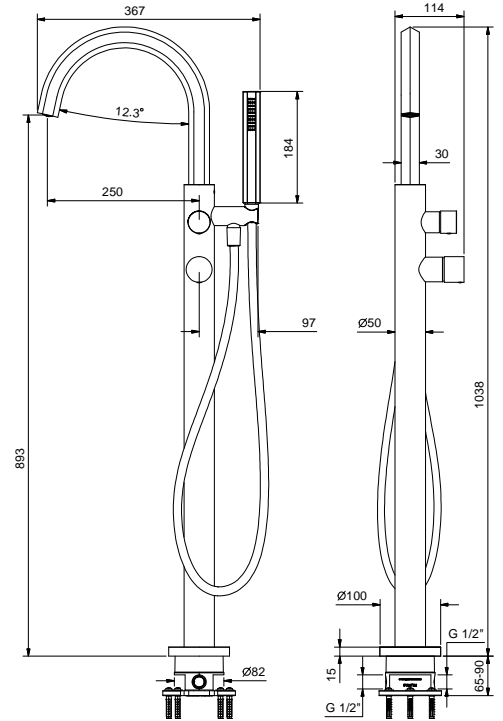

Caño bañera empotrado

- distancia a chorro 14,5 cm
- versión derecha
- cascada
- entrada de 1/2"

5041B

Parte externa

Cromo	31 02 5041B
Polished Nickel PVD	31 95 5041B
Matt Gun Metal PVD	31 P5 5041B
Matt British Gold PVD	31 P6 5041B
Matt Copper PVD	31 P9 5041B
Golden Look PVD	31 S9 5041B



5041A

Parte empotrable

31 00 5041A

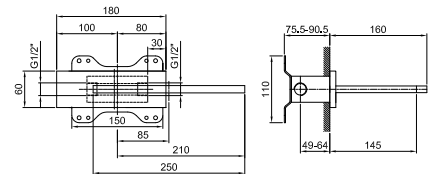

Caño bañera empotrado

- distancia a chorro 14,5 cm
- versión izquierda
- cascada
- entrada de 1/2"

5042B

Parte externa

Cromo	31 02 5042B
Polished Nickel PVD	31 95 5042B
Matt Gun Metal PVD	31 P5 5042B
Matt British Gold PVD	31 P6 5042B
Matt Copper PVD	31 P9 5042B
Golden Look PVD	31 S9 5042B



5041A

Parte empotrable

31 00 5041A

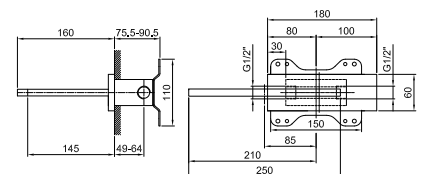

8315

Caño bañera a pared

- distancia a chorro 20 cm
- embellecedor redondo
- entrada de 1/2"



Cromo	29 02 8315
Polished Nickel PVD	29 95 8315
Matt Gun Metal PVD	29 P5 8315
Matt British Gold PVD	29 P6 8315
Matt Copper PVD	29 P9 8315
Golden Look PVD	29 S9 8315

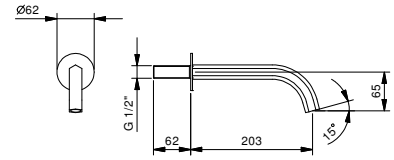

8418

Caño bañera a suelo

- distancia a chorro 24 cm
- entrada de 1/2"

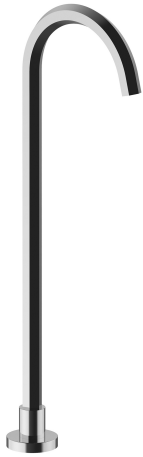

Cromo	29 02 8418
Polished Nickel PVD	29 95 8418
Matt Gun Metal PVD	29 P5 8418
Matt British Gold PVD	29 P6 8418
Matt Copper PVD	29 P9 8418
Golden Look PVD	29 S9 8418

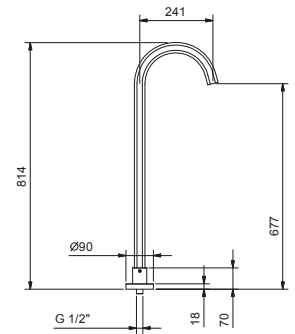

8434

Desagüe

- 1" 1/4
- tapón a presión
- para lavabo sin rebosadero
- para lavabo con rebosadero
- universal

N.B. listado completo de los acabados en la sección accesorios diversos al final de la tarifa



Cromo	91 02 8434
Polished Nickel PVD	91 95 8434
Matt Gun Metal PVD	91 P5 8434
Matt British Gold PVD	91 P6 8434
Matt Copper PVD	91 P9 8434
Golden Look PVD	91 S9 8434

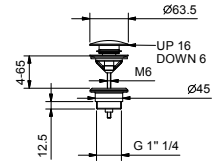

8435

Desagüe

- 1" 1/4
- para lavabo sin rebosadero
- para lavabo con rebosadero
- salida libre
- universal

N.B. listado completo de los acabados en la sección accesorios diversos al final de la tarifa



Cromo	91 02 8435
Polished Nickel PVD	91 95 8435
Matt Gun Metal PVD	91 P5 8435
Matt British Gold PVD	91 P6 8435
Matt Copper PVD	91 P9 8435
Golden Look PVD	91 S9 8435

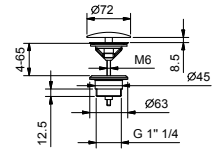

9234

Sifón de botella

- 1" 1/4
- para lavabo

N.B. listado completo de los acabados en la sección accesorios diversos al final de la tarifa



Cromo	91 02 9234
Polished Nickel PVD	91 95 9234
Matt Gun Metal PVD	91 P5 9234
Matt British Gold PVD	91 P6 9234
Matt Copper PVD	91 P9 9234
Golden Look PVD	91 S9 9234

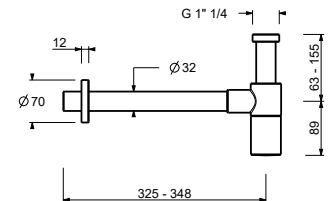

8364

Pareja de llaves de escuadra con filtro

- con cierre
- filtro inspeccionable
- entrada de 1/2"

N.B. listado completo de los acabados en la sección accesorios diversos al final de la tarifa



Cromo	91 02 8364
Polished Nickel PVD	91 95 8364
Matt Gun Metal PVD	91 P5 8364
Matt British Gold PVD	91 P6 8364
Matt Copper PVD	91 P9 8364
Golden Look PVD	91 S9 8364

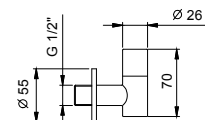

8402

Placa y pulsador descarga inodoro GEBERIT

- material básico: acero
- pulsadores en relieve
- con pulsadores redondos
- sin fijaciones visibles



N.B. listado completo de los acabados en la sección accesorios diversos al final de la tarifa

N.B. compatible SOLO CON Geberit Sigma 8/Sigma 12

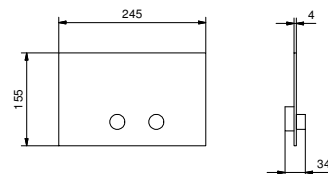

Acero Brillante	91 38 8402
Polished Nickel PVD	91 95 8402
Matt Gun Metal PVD	91 P5 8402
Matt British Gold PVD	91 P6 8402
Matt Copper PVD	91 P9 8402
Golden Look PVD	91 S9 8402

8403

Placa y pulsador descarga inodoro GEBERIT

- material básico: acero
- pulsadores enrasados
- con pulsadores cuadrados
- sin fijaciones visibles

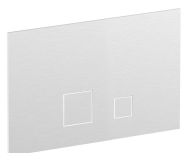

N.B. listado completo de los acabados en la sección accesorios diversos al final de la tarifa

N.B. compatible SOLO CON Geberit Sigma 8/Sigma 12

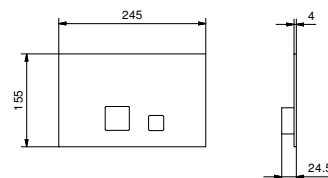

Acero Brillante	91 38 8403
Polished Nickel PVD	91 95 8403
Matt Gun Metal PVD	91 P5 8403
Matt British Gold PVD	91 P6 8403
Matt Copper PVD	91 P9 8403
Golden Look PVD	91 S9 8403

W216

Placa y pulsador descarga inodoro TECE

- material básico: acero
- pulsadores en relieve
- con pulsadores redondos
- profundidad mínima: consultar las instrucciones de montaje
- sin fijaciones visibles



N.B. listado completo de los acabados en la sección accesorios diversos al final de la tarifa

N.B. compatible SOLO CON Tecebox Octa II

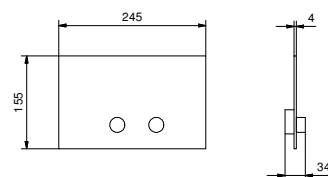

Acero Brillante	91 38 W216
Polished Nickel PVD	91 95 W216
Matt Gun Metal PVD	91 P5 W216
Matt British Gold PVD	91 P6 W216
Matt Copper PVD	91 P9 W216
Golden Look PVD	91 S9 W216

W001

Columna desagüe bañera

- CON DESAGÜE



N.B. listado completo de los acabados en la sección accesorios diversos al final de la tarifa

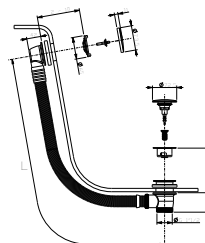

Cromo	91 02 W001
Polished Nickel PVD	91 95 W001
Matt Gun Metal PVD	91 P5 W001
Matt British Gold PVD	91 P6 W001
Matt Copper PVD	91 P9 W001
Golden Look PVD	91 S9 W001

W002

Columna desagüe bañera

- salida de agua en el rebosadero
- CON DESAGÜE

N.B. listado completo de los acabados en la sección accesorios diversos al final de la tarifa



Cromo	91 02 W002
Polished Nickel PVD	91 95 W002
Matt Gun Metal PVD	91 P5 W002
Matt British Gold PVD	91 P6 W002
Matt Copper PVD	91 P9 W002
Golden Look PVD	91 S9 W002

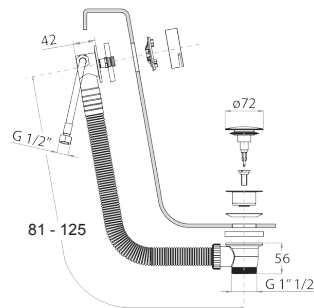

Z332

kit adaptador maneta Venezia By Venini a producto Venezia

- para artículos: N404SW - N404S - N504SW - N504S - N405SW - N409SW - N409S - N509SW - N509S



29 00 Z332

Z333

kit adaptador maneta Venezia By Venini a producto Venezia

- para artículos: N013SB - N113SB - N458SWB+R011A - N411SB+R011A - N511SB+R011A



Cromo	29 02 Z333
Polished Nickel PVD	29 95 Z333
Matt Gun Metal PVD	29 P5 Z333
Matt British Gold PVD	29 P6 Z333
Matt Copper PVD	29 P9 Z333
Golden Look PVD	29 S9 Z333



Fratelli Fantini Spa

Pella (Novara), Italy - t. +39 0322 918411

fantini@fantini.it - www.fantini.it